



Sky Air Advance-series
Air Conditioning
Technical Data
RZA-D



TABLE OF CONTENTS

RZA-D

1	Features	5
	RZA-D	5
2	Specifications	6
3	Electrical data	9
4	Options	10
5	Combination table	11
6	Capacity tables	12
	Cooling/Heating Capacity Tables	12
	Maximum heating capacity tables	14
7	Dimensional drawings	15
8	Centre of gravity	16
9	Piping diagrams	17
	Piping Diagram Twin Application	18
	Piping Diagram Triple Application	19
	Piping Diagram Double Twin Application	20
10	Wiring diagrams	21
	Wiring Diagrams - Single Phase	21
11	Sound data	22
	Sound Power Spectrum	22
	Sound Pressure Spectrum - Cooling	23
	Sound Pressure Spectrum - Heating	24
	Sound Pressure Spectrum Quiet Mode Level 1	25
	Sound Pressure Spectrum Quiet Mode Level 2	26
	Sound Pressure Spectrum Quiet Mode Level 3	27
12	Installation	28
	Installation Method	28
	Service Space	31
13	Operation range	32

14 Appropriate Indoors

33

1 Features

1 - 1 RZA-D

Large Sky Air system for commercial applications in the most compact casing ever

- › Compact (870mm high) and lightweight single fan design makes the unit unobtrusive, saves space and is easy to install
- › Market-leading serviceability and handling, thanks to wide access area, 7-segment display and additional handle
- › Choosing for an R-32 product, reduces the environmental impact with 68% compared to R-410A, leads directly to lower energy consumption thanks to its high energy efficiency and has a lower refrigerant charge
- › Replace existing systems with R-32 technology without needing to replace the piping
- › Guarantees operation in heating mode down to -20°C
- › Refrigerant cooled PCB guarantees reliable cooling, as it is not influenced by ambient temperature.
- › Maximum piping length up to 100m
- › Maximum installation height difference up to 30m
- › Outdoor units for pair, twin, triple, double twin application

1



Auto-restart
(standard)



Auto cooling-
heating
changeover

2 Specifications

1 - 1 RZA-D

2

Technical Specifications					RZA200D		RZA250D		
Casing	Colour	Ivory white							
	Material	Painted galvanized steel plate							
Dimensions	Unit	Height	mm					870	
		Width	mm					1,100	
		Depth	mm					460	
	Packed unit	Height	mm					1,050	
		Width	mm					1,205	
		Depth	mm					569	
Weight	Unit	kg					117		
	Packed unit	kg					127		
Packing	Weight	kg					10		
Heat exchanger	Fin	WF fin							
	Type Treatment	Anti-corrosion treatment (PE)							
Fan	Type	Propeller							
	Discharge direction	Horizontal							
	Quantity	1							
	Air flow rate	Cooling	Nom.	m ³ /min	101			119	
		Heating	Nom.	m ³ /min	126			142	
		Partial	m ³ /min					52 (1)	
Fan motor	Quantity	1							
	Model	Brushless DC motor							
	Output	W					600		
	Drive	Direct drive							
Compressor	Quantity	1							
	Type	Hermetically sealed scroll compressor							
Operation range	Cooling	Ambient	Min.	°CDB			-20		
			Max.	°CDB			46		
	Heating	Ambient	Min.	°CWB			-20		
			Max.	°CWB			15		
Sound power level	Cooling			73			76		
	Heating			76 (1)			79 (1)		
Sound pressure level	Cooling	Nom.	dB(A)	53			57		
	Heating	Nom.	dB(A)	60			63		
Refrigerant	Type	R-32							
	Charge	kg					5		
	Charge	TCO ₂ Eq					3.38		
Refrigerant	Control	Expansion valve (electronic type)							
	GWP	675							
	Circuits	Quantity					1		
Refrigerant oil	Type	FW68DE							
	Charged volume	l					3		
Piping connections	Liquid	Quantity					1		
		Type	Braze connection						
		OD	mm					9.52	
	Gas	Quantity					1		
		Type	Braze connection						
		OD	mm					22.2	
	Drain	Quantity					8		
		Type	Hole						
		OD	mm					26	
	Piping length	OU - IU	Min.	m					5
			Max.	m					100
		System	Chargeless	m					30
	Additional refrigerant charge	kg/m					See installation manual		
	Heat insulation	Both liquid and gas pipes							
Defrost control	Sensor for outdoor heat exchanger temperature								
Capacity control	Inverter controlled								
PED	Category	Category II							
	Most critical part	Name					Accumulator		
		Ps*V	Bar*I					172.3	
Safety devices	Item	01					High pressure switch		
		02					Low pressure switch		
	03					Fan motor driver overload protector			
	04					Overcurrent relay			
	05					Inverter overload protector			
	06					PC board fuse			

Standard accessories: Installation manual; Quantity: 1;

Standard accessories: General safety precautions; Quantity: 1;

Standard accessories: Tie-wraps; Quantity: 2;

Standard accessories: Peel off F-gas label; Quantity: 1;

Standard accessories: Connection pipes; Quantity: 6;

2 Specifications

1 - 1 RZA-D

Electrical Specifications			RZA200D	RZA250D
Power supply	Name		Y1	
	Phase		3~	
	Frequency	Hz	50	
	Voltage	V	380-415	
	Voltage range	V	342	
V		457		
Current	Zmax List		No requirements	
	Minimum Ssc value	kVa	2,169	
Wiring connections	For power supply Remark		See installation manual outdoor unit	
	For connection with Remark indoor		See installation manual outdoor unit	
Power supply intake			See installation manual outdoor unit	
Current - 50Hz	Maximum fuse amps (MFA)	A	20	

(1)According to ENER Lot 21

Technical specifications			FDA200A + RZA200D	FDA250A + RZA250D
Cooling capacity	Nom.	kW	19.0 (1)	22.0 (1)
Heating capacity	Nom.	kW	22.4 (2)	24.0 (2)
Space cooling	Capacity Pdesign	kW	19.0	22.0
	SEER		6.26	5.38
	$\eta_{s,c}$	%	247	212
	Annual energy consumption	kWh/a	1,821	2,455
Space heating (Average climate)	Capacity Pdesign	kW	11.2	12.1
	SCOP/A		3.59	3.55
	SCOPnet/A		3.59	3.55
	$\eta_{s,h}$	%	141	139
	Annual energy consumption	kWh/a	4,368	4,765
	Required back up heating cap at design conditions	kW	0.00	
Space cooling	A Condi- Pdc	kW	19.0	22.0
	tion (35°C EERd		2.69	2.51
	- 27/19) Power input	kW	7.06	8.76
	B Condi- Pdc	kW	14.1	16.2
	tion (30°C EERd		5.28	4.46
	- 27/19) Power input	kW	2.66	3.63
	C Condi- Pdc	kW	8.93	10.4
	tion (25°C EERd		8.89	7.22
	- 27/19) Power input	kW	1.00	1.44
	D Condi- Pdc	kW	4.66	4.60
tion (20°C EERd		8.51	6.92	
- 27/19) Power input	kW	0.55	0.67	
Space heating (Average climate)	TOL Tol (temperature operating limit)	°C	-10	
	Pdh (declared heating cap)	kW	11.2	12.1
	COPd (declared COP)		2.20	2.18
	Power input	kW	5.08	5.55
	TBivalent Tbiv (bivalent temperature)	°C	-10	
	Pdh (declared heating cap)	kW	11.2	12.1
	COPd (declared COP)		2.20	2.18
	Power input	kW	5.08	5.55
	A Con- Pdh (declared heating cap)	kW	9.86	10.7
	dition COPd (declared COP)		2.40	2.43
(-7°C) Power input	kW	4.11	4.41	
B Condi- Pdh (declared heating cap)	kW	6.05	6.52	
tion (2°C)				
Space heating (Average climate)	B Condi- COPd (declared COP)		3.39	
	tion (2°C) Power input	kW	1.78	1.92
	C Condi- Pdh (declared heating cap)	kW	3.92	4.19
	tion (7°C) COPd (declared COP)		5.04	4.84
	Power input	kW	0.78	0.87
	D Con- Pdh (declared heating cap)	kW	3.75	3.82
dition COPd (declared COP)		5.28	5.05	
(12°C) Power input	kW	0.71	0.76	

2 Specifications

1 - 1 RZA-D

2

Technical specifications					FDA200A + RZA200D	FDA250A + RZA250D	
Power consumption in other than active mode	Crank-case heater mode	Cooling	PCK	kW		0.031	
		Heating	PCK	kW		0.031	
	Off mode	Cooling	POFF	kW		0.031	
		Heating	POFF	kW		0.040	
	Standby mode	Cooling	PSB	kW		0.031	
		Heating	PSB	kW		0.040	
	Thermo-stat-off mode	Cooling	PTO	kW		0.018	
		Heating	PTO	kW		0.052	
	Indication if the heater is equipped with a supplementary heater (pair application)						No
	Supplementary heater (pair application)	Back-up capacity	Heating	elbu	kW		0.0
Cooling	Cdc (Degradation cooling)					0.25	
Heating	Cdh (Degradation heating)					0.25	
Cooling function included						Yes	
Heating function included						Yes	
Average climate included						Yes	
Cold season included						No	
Warm season included						No	

(1)Nominal cooling capacities are based on: indoor temperature: 27°CDB, 19°CWB, outdoor temperature: 35°CDB, equivalent refrigerant piping: 5m, level difference: 0m. |

(2)Nominal heating capacities are based on: indoor temperature: 20°CDB, outdoor temperature: 7°CDB, 6°CWB, equivalent refrigerant piping: 5m, level difference: 0m.

3 Electrical data

3 - 1 Electrical Data

RZA-D

Symbols

- MCA: Minimum Circuit Ampere [A]
- TOCA: Total overcurrent amps [A]
- MFA: Maximum Fuse Ampere [A]
- MSC: Maximum current of the starting compressor [A]
- RLA: Rated load amps [A]
- OFM: Outdoor fan motor
- IFM: Indoor fan motor
- FLA: Full Load Ampere [A]
- KW: Fan motor rated output [kW]

Notes

1. The ·RLA· is based on the following conditions.
 - Cooling
 - Indoor temperature ·27.0·°C DB / ·19.0·°C WB
 - Outdoor temperature ·35.0·°C DB
 - Heating
 - Indoor temperature ·20.0·°C DB
 - Outdoor temperature ·7.0·°C DB / ·6.0·°C WB
2. ·TOCA· is the total value of each overcurrent set.
3. Voltage range
 - The units are suitable for use with electrical systems in which the voltage supplied to the unit terminals is not below or above the listed range limits.
4. The maximum allowable voltage that is unbalanced between phases is ·2·%.
5. ·MCA· is the maximum input current.
 - The capacity of the ·MFA· must be greater than that of the ·MCA·.
 - Select the ·MFA· according to the table.
6. Select the wire size according to the MCA.
7. ·MFA· is used to select the circuit breaker and the ground fault circuit interruptor.
 - Earth leakage circuit breaker

3D125194A

RZA-D

Indoor	Outdoor	Power supply	Voltage range		Compressor			OFM		IFM					
					MCA	TOCA	MFA	MSC	RLA	kW	FLA	FLA			
FDA200A2VEB	RZA200D7Y1B	3N~ 50Hz 380-415V	Minimum: ·342· V. Maximum: ·457· V.	Minimum: ·342· V. Maximum: ·457· V.	(15,9)*	—	20	—	14,0	0,6	1,3	4,0			
FCAG50BVEB	x4 RZA200D7Y1B				16,1	—	20	—	13,0	0,6	1,3	0,3 x4			
FCAG60BVEB	x3 RZA200D7Y1B				16,7	—	20	—	13,9	0,6	1,3	0,3 x3			
FCAG71BVEB	x3 RZA200D7Y1B				16,7	—	20	—	13,9	0,6	1,3	0,3 x3			
FCAG100BVEB	x2 RZA200D7Y1B				16,4	—	20	—	13,1	0,6	1,3	0,7 x2			
FFA50A2VEB	x4 RZA200D7Y1B				16,5	—	20	—	13,0	0,6	1,3	0,4 x4			
FFA60A2VEB	x3 RZA200D7Y1B				17,7	—	20	—	13,9	0,6	1,3	0,6 x3			
FBA50A2VEB	x4 RZA200D7Y1B				(14,9)*	—	20	—	13,0	0,6	1,3	1,4 x4			
FBA60A2VEB	x3 RZA200D7Y1B				(15,8)*	—	20	—	13,9	0,6	1,3	1,3 x3			
FBA71A2VEB	x3 RZA200D7Y1B				(15,8)*	—	20	—	13,9	0,6	1,3	1,3 x3			
FBA100A2VEB	x2 RZA200D7Y1B				(15,0)*	—	20	—	13,1	0,6	1,3	3,5 x2			
FHA50AVEB	x4 RZA200D7Y1B				17,4	—	20	—	13,0	0,6	1,3	0,6 x4			
FHA60AVEB	x3 RZA200D7Y1B				17,7	—	20	—	13,9	0,6	1,3	0,6 x3			
FHA71AVEB	x3 RZA200D7Y1B				18,3	—	20	—	13,9	0,6	1,3	0,8 x3			
FHA100AVEB	x2 RZA200D7Y1B				17,7	—	20	—	13,1	0,6	1,3	1,3 x2			
FUA71AVEB	x3 RZA200D7Y1B				18,6	—	20	—	13,9	0,6	1,3	0,9 x3			
FUA100AVEB	x2 RZA200D7Y1B				17,7	—	20	—	13,1	0,6	1,3	1,3 x2			
FAA71BUV1B	x3 RZA200D7Y1B				17,4	—	20	—	13,9	0,6	1,3	0,5 x3			
FAA100BUV1B	x2 RZA200D7Y1B				16,0	—	20	—	13,1	0,6	1,3	0,5 x2			
FVA71AMVEB	x3 RZA200D7Y1B				18,3	—	20	—	13,9	0,6	1,3	0,8 x3			
FVA100AMVEB	x2 RZA200D7Y1B				18,1	—	20	—	13,1	0,6	1,3	1,5 x2			
FDX M50F3V1B	x4 RZA200D7Y1B				18,6	—	20	—	13,0	0,6	1,3	0,9 x4			
FDX M60F3V1B	x3 RZA200D7Y1B				18,6	—	20	—	13,9	0,6	1,3	0,9 x3			
FNA50A2VEB	x4 RZA200D7Y1B				17,0	—	20	—	13,0	0,6	1,3	0,5 x4			
FNA60A2VEB	x3 RZA200D7Y1B				17,7	—	20	—	13,9	0,6	1,3	0,6 x3			
FDA250A2VEB	RZA250D7Y1B				3N~ 50Hz 380-415V	Minimum: ·342· V. Maximum: ·457· V.	Minimum: ·342· V. Maximum: ·457· V.	(15,9)*	—	20	—	14,0	0,6	1,3	4,3
FCAG60BVEB	x4 RZA250D7Y1B							17,2	—	20	—	14,0	0,6	1,3	0,3 x4
FCAG125BVEB	x2 RZA250D7Y1B							18,2	—	20	—	13,6	0,6	1,3	1,3 x2
FFA60A2VEB	x4 RZA250D7Y1B							18,4	—	20	—	14,0	0,6	1,3	0,6 x4
FBA60A2VEB	x4 RZA250D7Y1B							(15,9)*	—	20	—	14,0	0,6	1,3	1,3 x4
FBA125A2VEB	x2 RZA250D7Y1B							(15,5)*	—	20	—	13,6	0,6	1,3	3,6 x2
FHA60AVEB	x4 RZA250D7Y1B							18,4	—	20	—	14,0	0,6	1,3	0,6 x4
FHA125AVEB	x2 RZA250D7Y1B	18,6	—	20				—	13,6	0,6	1,3	1,5 x2			
FUA125AVEB	x2 RZA250D7Y1B	18,4	—	20				—	13,6	0,6	1,3	1,4 x2			
FDA125A5VEB	x2 RZA250D7Y1B	19,9	—	20				—	13,6	0,6	1,3	2,1 x2			
FVA125AMVEB	x2 RZA250D7Y1B	18,6	—	20				—	13,6	0,6	1,3	1,5 x2			
FDX M60F3V1B	x4 RZA250D7Y1B	19,7	—	20				—	14,0	0,6	1,3	0,9 x4			
FNA60A2VEB	x4 RZA250D7Y1B	18,4	—	20				—	14,0	0,6	1,3	0,6 x4			

* Use a separate power supply for the indoor unit. The value between brackets is the MCA of the outdoor unit. For the MCA of the indoor unit, see the installation manual of the indoor unit.

3D125194A

4 Options

4 - 1 Options

RZA-D
4

Available options for ·RZA200/250D7Y1B· models

		Option kit	
		RZA200D7Y1B	RZA250D7Y1B
Refrigerant branch piping	Twin	KHRQ(M)22M20TA	
	Triple	KHRQ(M)250H7	
	Double twin	KHRQ(M)22M20TA (3x)	
Demand adaptor kit		KRP58M51	
Mounting plate		EKMKA3	
Bottom plate heater		EKBPH250D7	
Sound reduction enclosure		EKLN140A1	

4D125196A

5 Combination table

5 - 1 Combination Table

RZA-D

Combination table

Units	Duct	High Cassette	Thin cassette			2x2 cassette			Duct (medium ESP)			Ceiling-suspended			Ceiling-mounted - 4-way blow	Wall mounted type	Duct (high ESP)																							
Model name	FDA200A2VEB RZA200D7Y1B	FDA250A2VEB RZA250D7Y1B	FAHG71HVEB	FAHG100HVEB	FAHG125HVEB	FAHG140HVEB	FCAG38BVEB	FCAG50BVEB	FCAG60BVEB	FCAG71BVEB	FCAG100BVEB	FCAG125BVEB	FCAG140BVEB	FFA25A2VEB9	FFA35A2VEB9	FFA50A2VEB9	FFA60A2VEB9	FBA35A2VEB9	FBA50A2VEB9	FBA60A2VEB9	FBA71A2VEB9	FBA100A2VEB	FBA125A2VEB	FBA140A2VEB	FHA35AVEB9	FHA50AVEB9	FHA60AVEB9	FHA71AVEB9	FHA100AVEB	FHA125AVEB	FHA140AVEB	FUA71AVEB	FUA100AVEB	FUA125AVEB	FAA71BUV1B	FAA100BUV1B	FDA125A5VEB			
	P	P					4	3	3	2					4	3	4	3	3	3	2					4	3	3	2		3	2		3	2		2			

Units	Floor standing type		Slim duct			Concealed floor standing type					
Model name	FVA71AMVEB	FVA100AMVEB	FVA125AMVEB	FVA140AMVEB	FDXMG3F3V1B9	FDXMG5F3V1B9	FDXMG6F3V1B9	FNA35A2VEB9	FNA50A2VEB9	FNA60A2VEB9	
RZA200D7Y1B	3	2			4	3	4			4	3
RZA250D7Y1B			2				4				4

P= Pair
2= Twin
3= Triple
4= Double twin

Notes

- Maximum capacity is limited based on outdoor unit capacity.
- When combining multiple indoor units, designate the unit whose remote controller is equipped with the most functions as the master unit.
- For the selection of the correct refnet kit, required to install a multi-combination, refer to the option list.

Twin : KHRQ(M)22M20TA
Triple : KHRQ(M)250H7
Double twin : KHRQ(M)22M20TA

3D125195

6 Capacity tables

6 - 1 Cooling/Heating Capacity Tables

RZA200D

Cooling

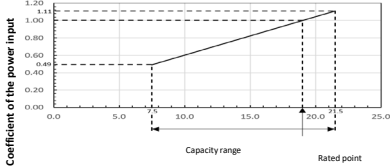

Heating

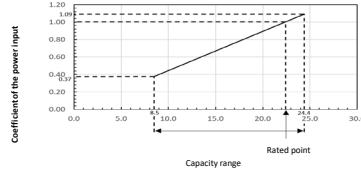

Symbols
 AFR: Air flow rate (m³/min)
 BF: Bypass factor
 EWB: Entering wet-bulb temperature [°C WB]
 EDB: Entering dry-bulb temperature [°C DB]
 TC: Maximum total cooling/heating capacity [kW]
 SHC: Sensible heat capacity [kW]
 CPI: Coefficient of the power input
 PI: Power input [kW]
 compressor + indoor and outdoor fan motors

Indoor [°C WB]	Cooling capacity [kW]											
	Outdoor temperature [°C DB]											
	25			30			35			40		
TC	SHC	CPI	TC	SHC	CPI	TC	SHC	CPI	TC	SHC	CPI	
16	21.6	0.91	20.8	17.5	1.00	20.1	16.7	1.10	19.4	16.2	1.19	
18	22.6	0.91	21.8	17.5	1.01	21.0	16.9	1.11	20.3	16.2	1.20	
19	23.1	0.92	22.3	17.5	1.01	21.5	16.8	1.11	20.7	16.2	1.21	
20	23.6	0.92	22.8	17.5	1.02	22.0	16.7	1.11	21.2	16.1	1.21	
22	24.6	0.93	23.8	17.3	1.02	22.9	16.7	1.12	22.1	16.0	1.22	
24	25.6	0.93	24.7	17	1.03	23.8	16.4	1.13	23.0	15.8	1.23	

- Notes
- The ratings shown are net capacities which include a correction for indoor fan motor heat.
 - = Maximum at standard conditions
□ = Rated capacity and rated coefficient of the power input
The maximum capacity is not guaranteed except at standard conditions.
 - SHC is based on indoor units - EWB & EDB.
SHC* for other dry-bulb temperatures = SHC + SHC*
SHC* = SHC correction for other dry-bulb temperatures
= 0.02 x AFR (m³/min) x (1-BF) x (DB* - EDB)
 - The capacities are based on the following conditions:
Outdoor air: 85% RH
However, the outdoor ambient condition of the rated capacity during heating operation is 7°C DB / 6°C WB.
Corresponding refrigerant piping length: 5.0 m
Level difference: 0 m
 - CPI is a percentage value compared to the rated value which is 1.00.
 - The error rate for this value is less than 5% and depends on the indoor unit type.
 - The heating performance takes into account the drop that occurs during defrost operation.
 - The air flow rate and bypass factor are mentioned in the table.

Indoor [°C DB]	Heating capacity [kW]											
	Outdoor temperature [°C WB]											
	-15		-11		-8		-6		-1		10	
TC	CPI	TC	CPI	TC	CPI	TC	CPI	TC	CPI	TC	CPI	
16	12.5	0.90	14.1	0.95	15.3	0.97	16.0	0.99	17.9	1.05	24.7	1.06
18	12.5	0.92	14.1	0.96	15.2	0.99	15.9	1.01	17.8	1.06	24.6	1.07
20	12.4	0.92	14.0	0.96	15.1	1.01	15.8	1.02	17.7	1.06	24.4	1.09
22	12.2	0.95	13.9	0.99	15.0	1.02	15.7	1.05	17.5	1.10	24.2	1.11
24	12.1	0.96	13.7	1.01	14.8	1.05	15.6	1.07	17.4	1.11	24.1	1.12

9. The rated power input for each model is mentioned in the table below.

Pair	FDA200A
AFR	64
(BF)	(0.3)

Pair	FDA200A
Cooling	7.06
Heating	6.93

Twin	FCAG100Bx2	FBA100Ax2	FHA100Ax2	FVA100Ax2	FUA100Ax2	FAA100Bx2
AFR	22.8x2	29.0x2	28.0x2	28.0x2	31.0x2	26.0x2
(BF)	(0.17x2)	(0.03x2)	(0.09x2)	(0.20x2)	(0.20x2)	(0.10x2)

Twin	FCAG100Bx2	FBA100Ax2	FHA100Ax2	FVA100Ax2	FUA100Ax2	FAA100Bx2
Cooling	6.61	7.52	5.96	5.82	6.09	7.11
Heating	6.54	6.49	6.63	6.74	6.07	7.77

Triple	FCAG60Bx3	FCAG71Bx3	FBA60Ax3	FBA71Ax3	FHA60Ax3	FHA71Ax3
AFR	14.5x3	16.0x3	16.0x3	18.0x3	23.0x3	18.0x3
(BF)	(0.20x3)	(0.14x3)	(0.13x3)	(0.13x3)	(0.20x3)	(0.13x3)

Triple	FCAG60Bx3	FCAG71Bx3	FBA60Ax3	FBA71Ax3	FHA60Ax3	FHA71Ax3
Cooling	5.58	7.40	7.45	6.97	5.97	5.30
Heating	7.15	6.97	6.43	6.20	7.13	6.41

Triple	FFA60Ax3	FDXM60F3	FNA60Ax3	FVA71Ax3	FUA71Ax3	FAA71Bx3
AFR	14.5x3	16.0x3	16.0x3	18.0x3	23.0x3	18.0x3
(BF)	(0.13x3)	(0.12x3)	(0.12x3)	(0.16x3)	(0.24x3)	(0.16x3)

Triple	FFA60Ax3	FDXM60F3	FNA60Ax3	FVA71Ax3	FUA71Ax3	FAA71Bx3
Cooling	8.08	5.20	5.22	6.31	5.81	6.25
Heating	7.69	6.83	6.73	7.10	5.50	6.73

Double twin	FCAG50Bx4	FBA50Ax4	FHA50Ax4	FFA50Ax4	FDXM50F4	FNA50Ax4
AFR	12.6x4	15.0x4	15.0x4	12.0x4	15.8x4	16.0x4
(BF)	(0.22x4)	(0.13x4)	(0.18x4)	(0.16x4)	(0.11x4)	(0.11x4)

Double twin	FCAG50Bx4	FBA50Ax4	FHA50Ax4	FFA50Ax4	FDXM50F4	FNA50Ax4
Cooling	5.96	6.15	5.95	6.59	4.76	4.79
Heating	6.40	6.20	6.34	7.54	5.94	5.83

3D125190C

RZA250D

Cooling

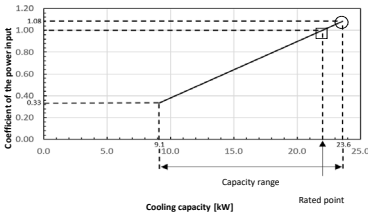

Heating

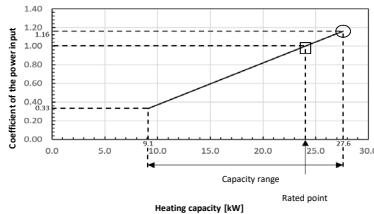

Symbols
 AFR: Air flow rate (m³/min)
 BF: Bypass factor
 EWB: Entering wet-bulb temperature [°C WB]
 EDB: Entering dry-bulb temperature [°C DB]
 TC: Maximum total cooling/heating capacity [kW]
 SHC: Sensible heat capacity [kW]
 CPI: Coefficient of the power input
 PI: Power input [kW]
 compressor + indoor and outdoor fan motors

Indoor [°C WB]	Cooling capacity [kW]											
	Outdoor temperature [°C DB]											
	25			30			35			40		
TC	SHC	CPI	TC	SHC	CPI	TC	SHC	CPI	TC	SHC	CPI	
16	23.7	0.88	22.9	20.1	0.98	22.1	19.4	1.07	21.2	18.8	1.17	
18	24.8	0.89	23.9	20.0	0.99	23.1	19.4	1.08	22.2	18.7	1.17	
19	25.3	0.89	24.5	20.0	0.99	23.6	19.4	1.08	22.7	18.8	1.18	
20	25.9	0.90	25.0	19.9	0.99	24.1	19.3	1.09	23.2	18.7	1.18	
22	27.0	0.90	26.1	19.7	1.00	25.1	19.1	1.09	24.2	18.5	1.19	
24	28.1	0.91	27.1	19.6	1.01	26.2	18.9	1.10	25.2	18.1	1.20	

Indoor [°C DB]	Heating capacity [kW]											
	Outdoor temperature [°C WB]											
	-15		-11		-8		-6		-1		10	
TC	CPI	TC	CPI	TC	CPI	TC	CPI	TC	CPI	TC	CPI	
16	14.0	0.89	15.6	0.95	16.8	0.99	17.6	1.01	19.5	1.06	28.1	1.07
18	13.9	0.93	15.5	0.99	16.6	1.02	17.4	1.05	19.3	1.10	27.8	1.12
20	13.7	0.98	15.4	1.02	16.5	1.06	17.3	1.09	19.1	1.15	27.6	1.16
22	13.6	1.01	15.1	1.07	16.3	1.10	17.0	1.13	18.9	1.20	27.4	1.21
24	13.4	1.05	15.0	1.10	16.2	1.15	16.9	1.17	18.7	1.23	27.1	1.26

- Notes
- The ratings shown are net capacities which include a correction for indoor fan motor heat.
 - = Maximum at standard conditions
□ = Rated capacity and rated coefficient of the power input
The maximum capacity is not guaranteed except at standard conditions.
 - SHC is based on indoor units - EWB & EDB.
SHC* for other dry-bulb temperatures = SHC + SHC*
SHC* = SHC correction for other dry-bulb temperatures
= 0.02 x AFR (m³/min) x (1-BF) x (DB* - EDB)
 - The capacities are based on the following conditions:
Outdoor air: 85% RH
However, the outdoor ambient condition of the rated capacity during heating operation is 7°C DB / 6°C WB.
Corresponding refrigerant piping length: 5.0 m
Level difference: 0 m
 - CPI is a percentage value compared to the rated value which is 1.00.
 - The error rate for this value is less than 5% and depends on the indoor unit type.
 - The heating performance takes into account the drop that occurs during defrost operation.
 - The air flow rate and bypass factor are mentioned in the table.

9. The rated power input for each model is mentioned in the table below.

Pair	FDA250A
AFR	69
(BF)	(0.25)

Pair	FDA250A
Cooling	8.76
Heating	7.69

Twin	FCAG125Bx2	FBA125Ax2	FHA125Ax2	FVA125Ax2	FUA125Ax2	FDA125Ax2
AFR	26.0x2	34.0x2	31.0x2	28.0x2	32.5x2	39.0x2
(BF)	(0.21x2)	(0.06x2)	(0.14x2)	(0.16x2)	(0.19x2)	(0.16x2)

Twin	FCAG125Bx2	FBA125Ax2	FHA125Ax2	FVA125Ax2	FUA125Ax2	FDA125Ax2
Cooling	7.75	8.07	7.60	8.10	8.09	7.44
Heating	7.56	7.52	7.41	7.52	6.90	6.94

Double twin	FCAG60Bx4	FBA60Ax4	FHA60Ax4	FFA60Ax4	FDXM60F4	FNA60Ax4
AFR	13.6x4	18.0x4	19.5x4	14.5x4	16.0x4	16.0x4
(BF)	(0.20x4)	(0.15x4)	(0.20x4)	(0.11x4)	(0.12x4)	(0.12x4)

Double twin	FCAG60Bx4	FBA60Ax4	FHA60Ax4	FFA60Ax4	FDXM60F4	FNA60Ax4
Cooling	7.24	6.92	6.83	8.44	5.93	6.02
Heating	7.14	6.43	7.33	7.53	6.83	6.75

3D125191A

6 Capacity tables

6 - 1 Cooling/Heating Capacity Tables

RZA-D

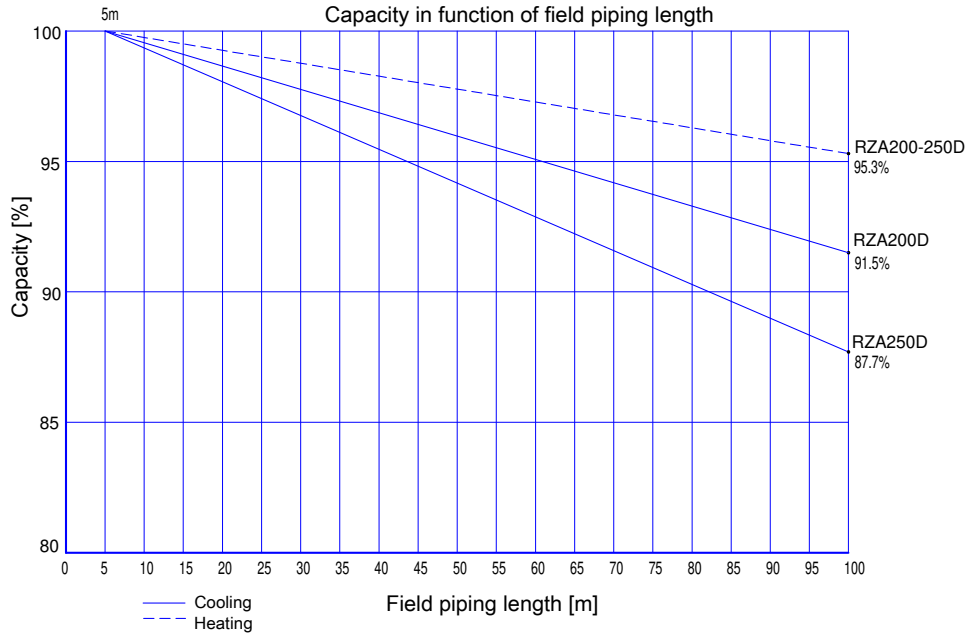

3D125192

6 Capacity tables

6 - 2 Maximum heating capacity tables

6
RZA-D

Heating

RZA200D7Y1B

Indoor	Outdoor temperature [°C WB]						
	-15	-11	-8	-6	-1	6	10
	TC	TC	TC	TC	TC	TC	TC
[°C DB]	[kW]	[kW]	[kW]	[kW]	[kW]	[kW]	[kW]
20	13,3	15,4	17,0	18,1	20,7	24,4	26,6

RZA250D7Y1B

Indoor	Outdoor temperature [°C WB]						
	-15	-11	-8	-6	-1	6	10
	TC	TC	TC	TC	TC	TC	TC
[°C DB]	[kW]	[kW]	[kW]	[kW]	[kW]	[kW]	[kW]
20	14,5	16,9	18,6	19,8	23,5	27,6	30,0

Symbols

TC: Maximum total heating capacity [kW]

Notes

- The ratings shown are peak capacities which include a correction for indoor fan motor heat.
- The capacities are based on the following conditions:
 Outdoor air: ·85% RH·
 However, the outdoor ambient condition of the rated capacity during heating operation is ·7°C DB/6°C WB·.
 Corresponding refrigerant piping length: ·5· m
 Level difference: ·0·m
- The error rate for this value is less than ·5·% and depends on the indoor unit type.

3D125193A

7 Dimensional drawings

7 - 1 Dimensional Drawings

RZA-D

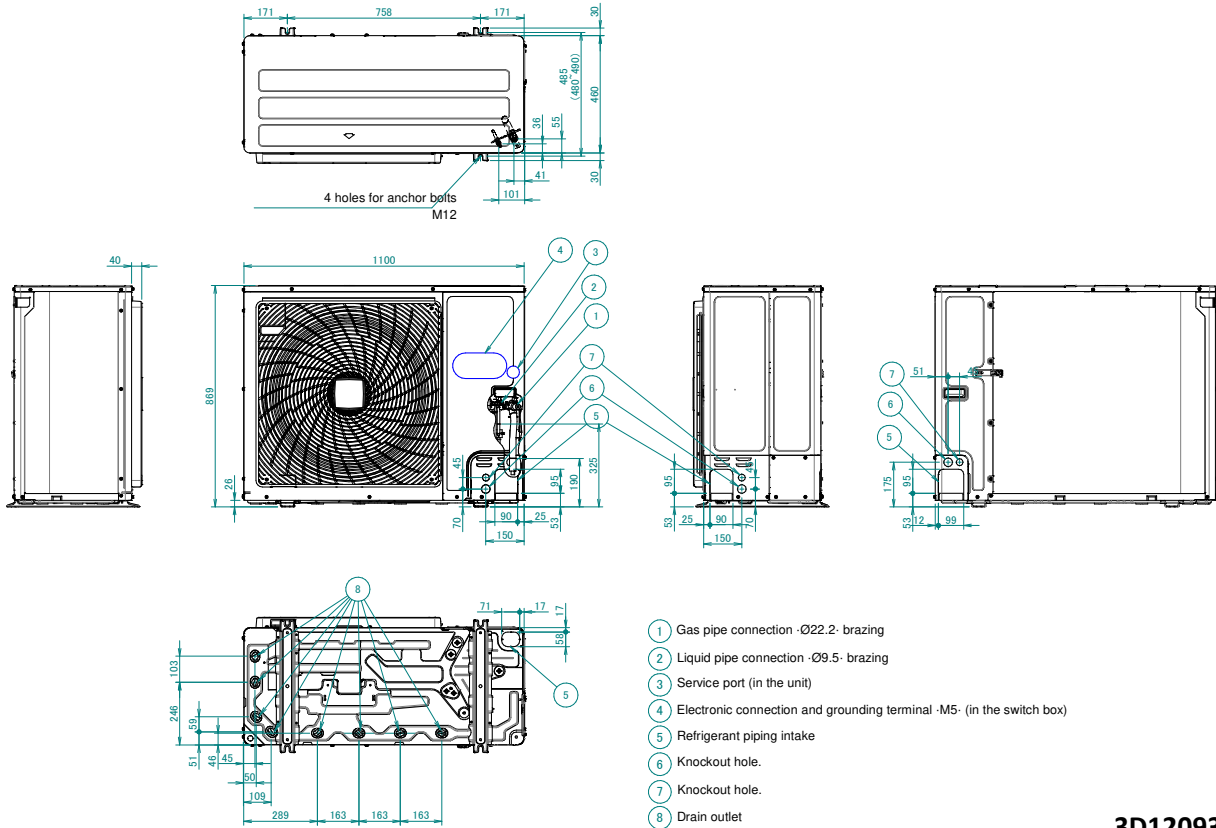

3D120937

8 Centre of gravity

8 - 1 Centre of Gravity

8

RZA-D

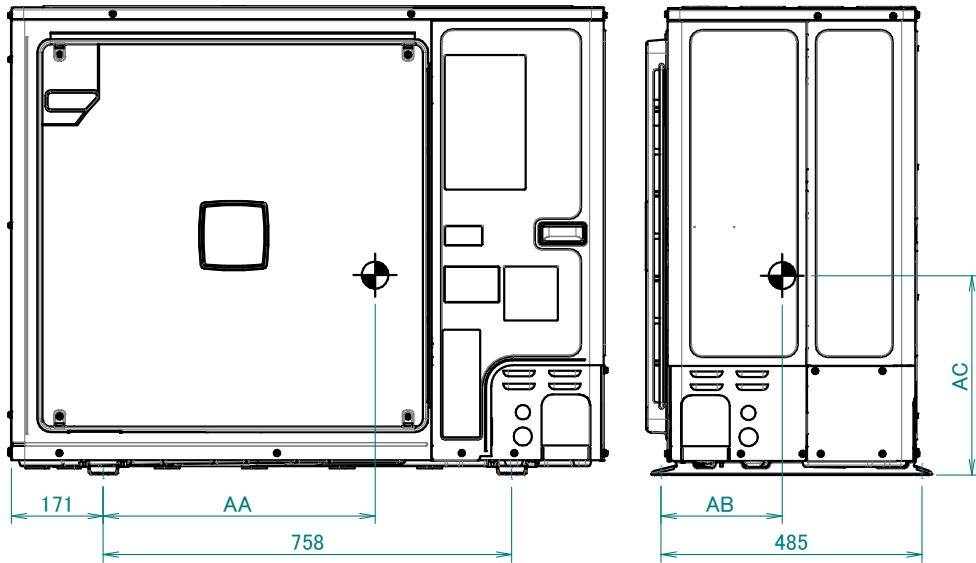

Model	AA	AB	AC
RZA200/250D	703.9	239.0	385.1

4D120934A

9 Piping diagrams

9 - 1 Piping Diagrams

RZA-D

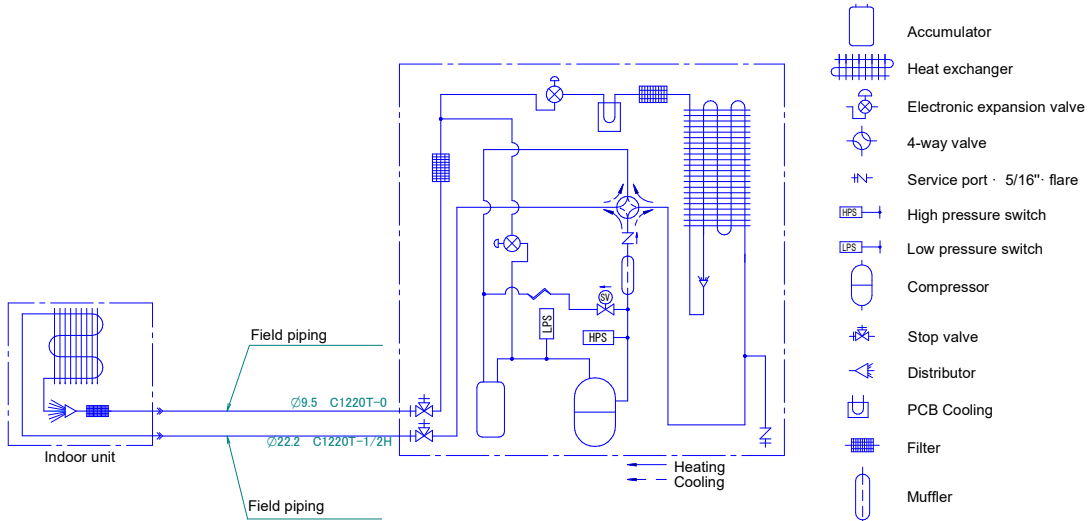

Notes
 1. The pipes between the branch and the indoor units should have the same size as the indoor connections.

3D120908

9 Piping diagrams

9 - 2 Piping Diagram Twin Application

9

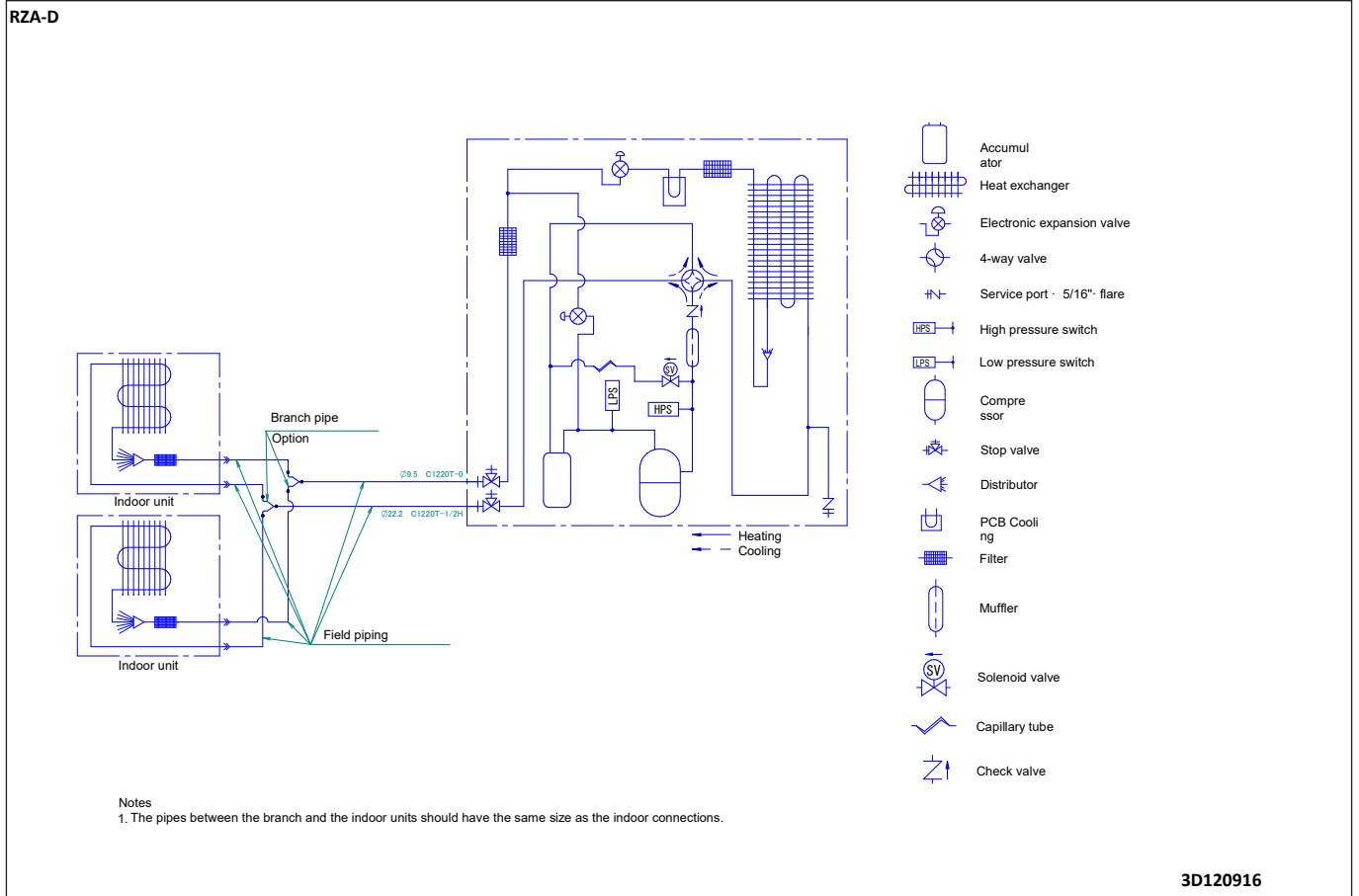

9 Piping diagrams

9 - 3 Piping Diagram Triple Application

RZA-D

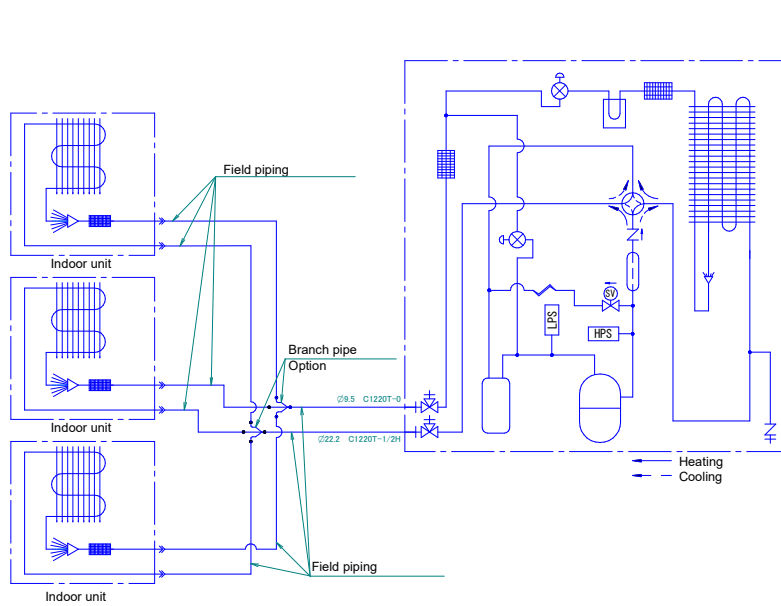

- Accumulator
- Heat exchanger
- Electronic expansion valve
- 4-way valve
- Service port · 5/16" flare
- High pressure switch
- Low pressure switch
- Compressor
- Stop valve
- Distributor
- PCB Cooling
- Filter
- Muffler
- Solenoid valve
- Capillary tube
- Check valve

Notes
 1. The pipes between the branch and the indoor units should have the same size as the indoor connections.

3D120917

9 Piping diagrams

9 - 4 Piping Diagram Double Twin Application

9

RZA-D

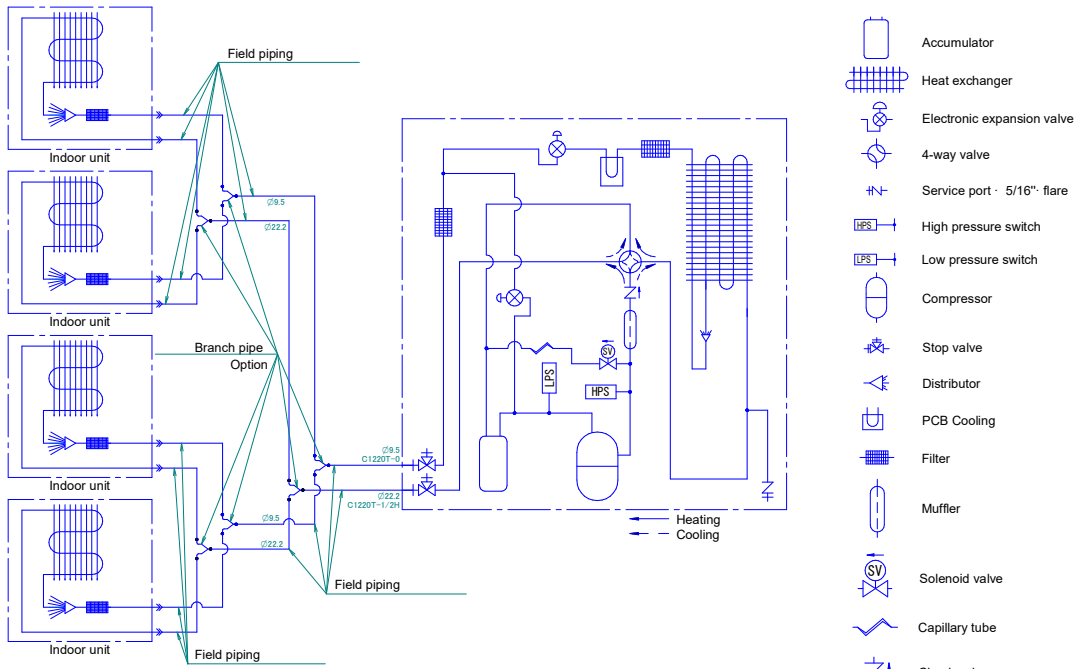

Notes
 1. The pipes between the branch and the indoor units should have the same size as the indoor connections.

3D120918

10 Wiring diagrams

10 - 1 Wiring Diagrams - Single Phase

RZA-D

(1) Connection diagram

(2) Layout

(3) NOTES

	: Connection		: switch box
	: Main terminal		: PCB
	: Earth wiring		: Wiring depending on model
	: Field supply		: Protective earth
	: Option		: Field wire

(4) LEGEND

Part n°	Description
A1P	Printed circuit board (main)
A2P	Printed circuit board (noise filter)
A3P	Printed circuit board (inverter)
A4P	Printed circuit board (fan)
A5P	* Printed circuit board (demand)
BS1-BS3 (A1P)	Push-button switch
C503, C506, C507 (A3P)	Capacitor
DS1, DS2 (A1P)	Dipswitch
E1H	* Bottomplate heater
E1HC	Crankcase heater
F1U (A1P)	Fuse (T 3, 15 A 250 V)
F8U, F9U	* Fuse (F)
F101U (A4P)	Fuse
F101-102U (A2P)	Fuse
F601U (A3P)	Fuse
HAP (A1P, A3-4P)	LED (service monitor is green)
K1R (A1P)	Magnetic relay (Y2S)
K3R (A3P)	Magnetic relay
K3R (A1P)	Magnetic relay (Y3S)
K5R (A1P)	Magnetic relay (E1HC)
K7R (A1P)	Magnetic relay (E1H)
L1R	Reactor
M1C	Compressor motor
M1F	Fan motor
PS (A1P, A3P)	Switching power supply
Q1DI	Earth leakage circuit breaker
Q1LD (A1P)	Earth current detector
R1T	Thermistor (air)
R2T	Thermistor (discharge pipe)
R3T	Thermistor (suction pipe)
R4T	Thermistor (heat exchanger exit)
R5T	Thermistor (heat exchanger branch)
R6T	Thermistor (liquid pipe)
R7T	Thermistor (M1C body)
R24 (A4P)	Resistor (current sensor)
R300 (A3P)	Resistor (current sensor)
S1PH	High pressure switch
S1PL	Low pressure switch
SEG1-SEG3 (A1P)	7-segment display
T1A	current sensor
V1D (A3P)	Diode
V1R (A3P, A4P)	Diode module
X*A	Connector
X*M	Terminal block
Y1E	Electronic exp. valve (main)
Y2E	Electronic exp. valve (injection)
Y2S	Solenoid valve (4-way valve)
Y3S	Solenoid valve (pressure equal.)
Z*C	Noise filter (ferrite core)
Z1F (A2P)	Noise filter

* : optional

NOTES

- Refer to the wiring diagram sticker (on the back of the front plate) for how to use the BS1-BS3 and DS1 switches.
- When operating, do not short-circuit protection device(s) S1PH and S1PL.
- Refer to the combination table and the option manual for how to connect the wiring to X801M.
- Colours: BLK:black; RED:red; BLU:blue; WHT:white; GRN:green

4D124870

11 Sound data

11 - 1 Sound Power Spectrum

11

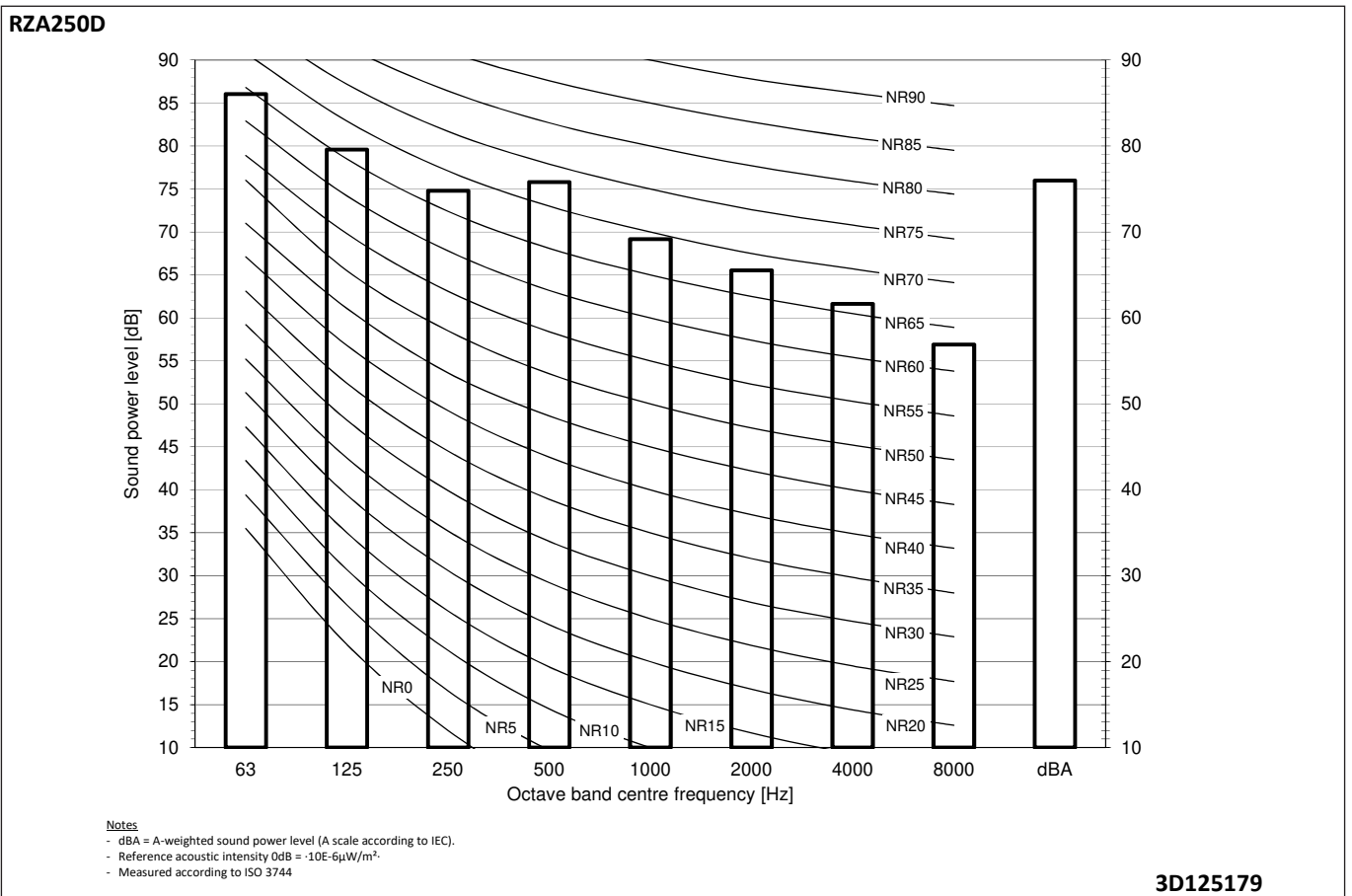
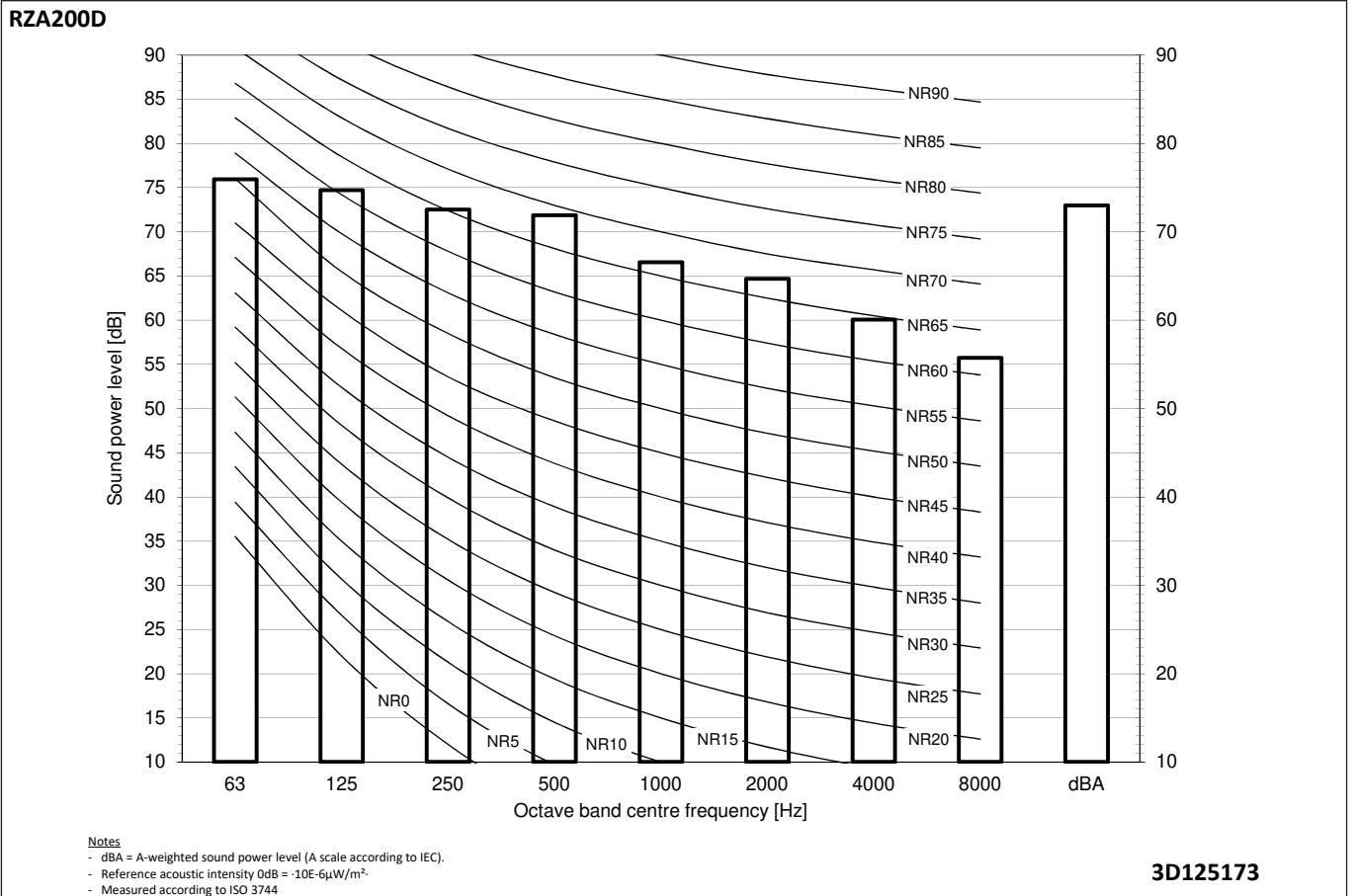

11 Sound data

11 - 2 Sound Pressure Spectrum - Cooling

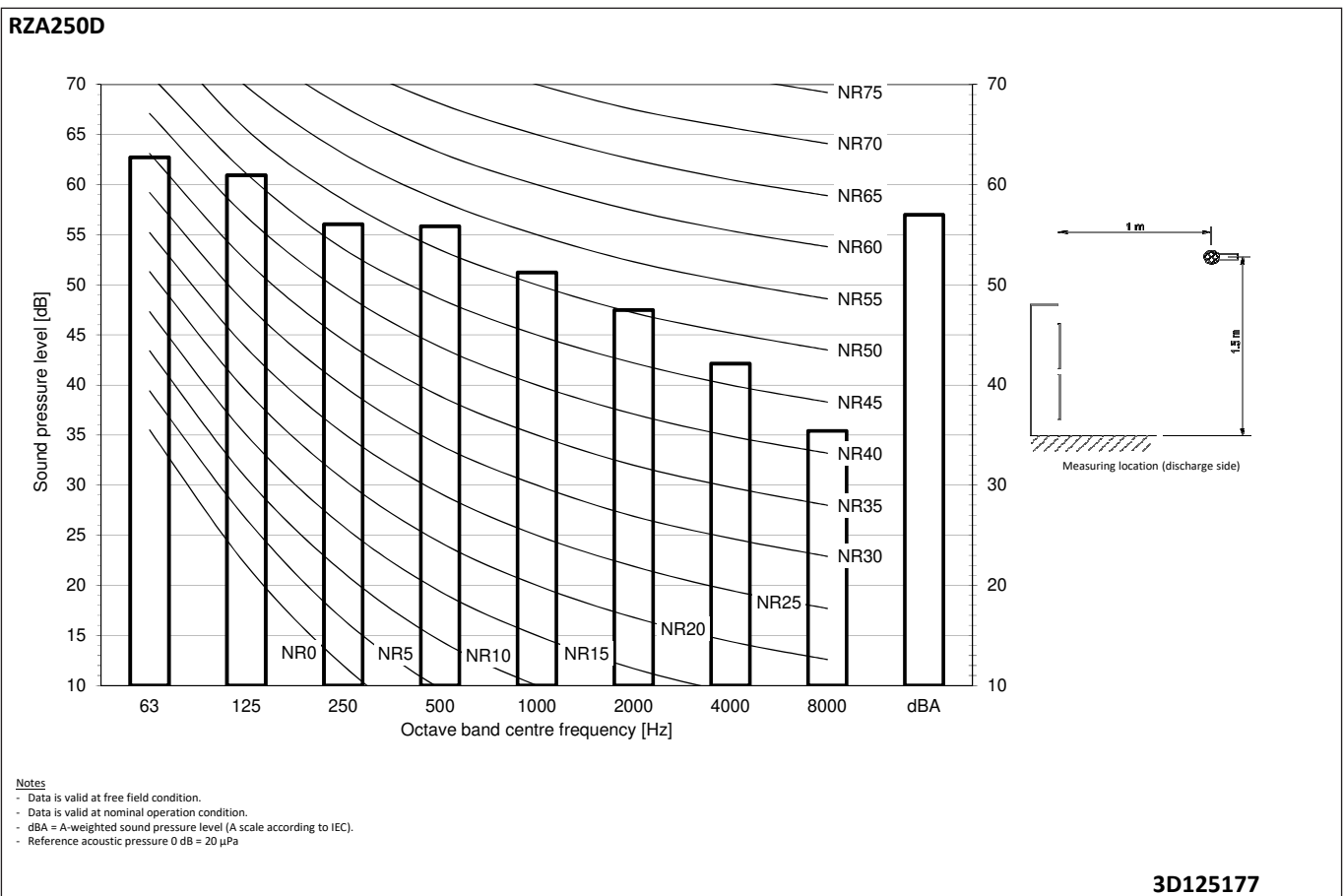
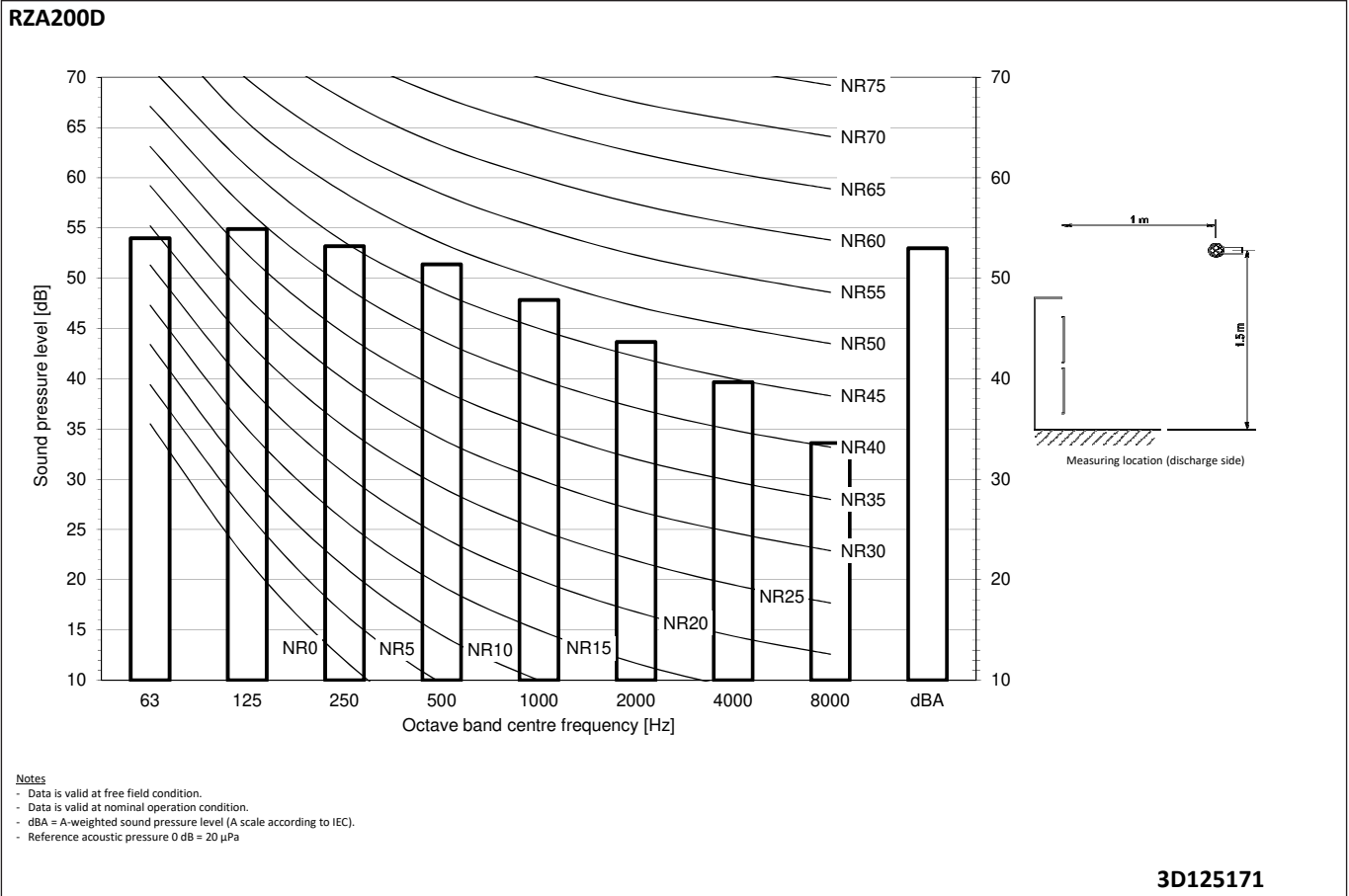

11 Sound data

11 - 3 Sound Pressure Spectrum - Heating

RZA200D

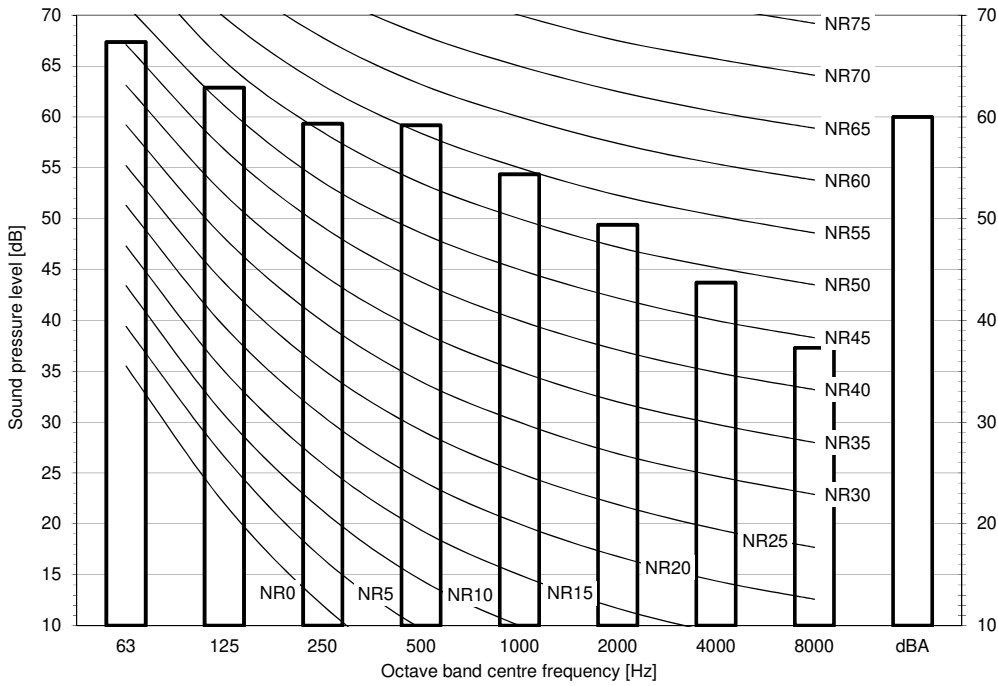

Notes

- Data is valid at free field condition.
- Data is valid at nominal operation condition.
- dBA = A-weighted sound pressure level (A scale according to IEC).
- Reference acoustic pressure 0 dB = 20 μPa

3D125172

RZA250D

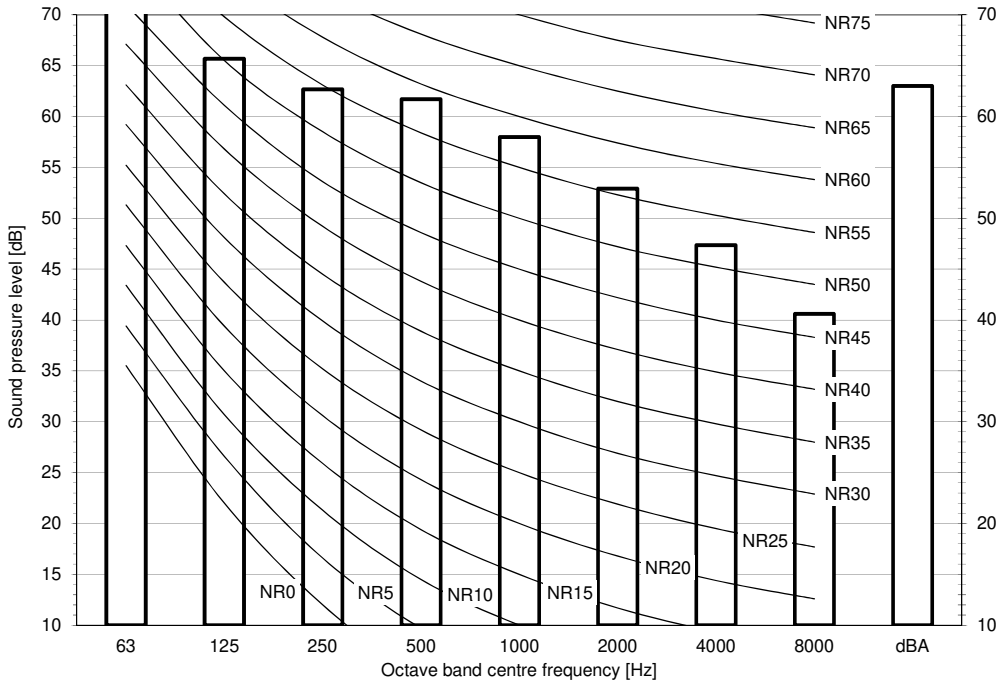

Notes

- Data is valid at free field condition.
- Data is valid at nominal operation condition.
- dBA = A-weighted sound pressure level (A scale according to IEC).
- Reference acoustic pressure 0 dB = 20 μPa

3D125178

11 Sound data

11 - 4 Sound Pressure Spectrum Quiet Mode Level 1

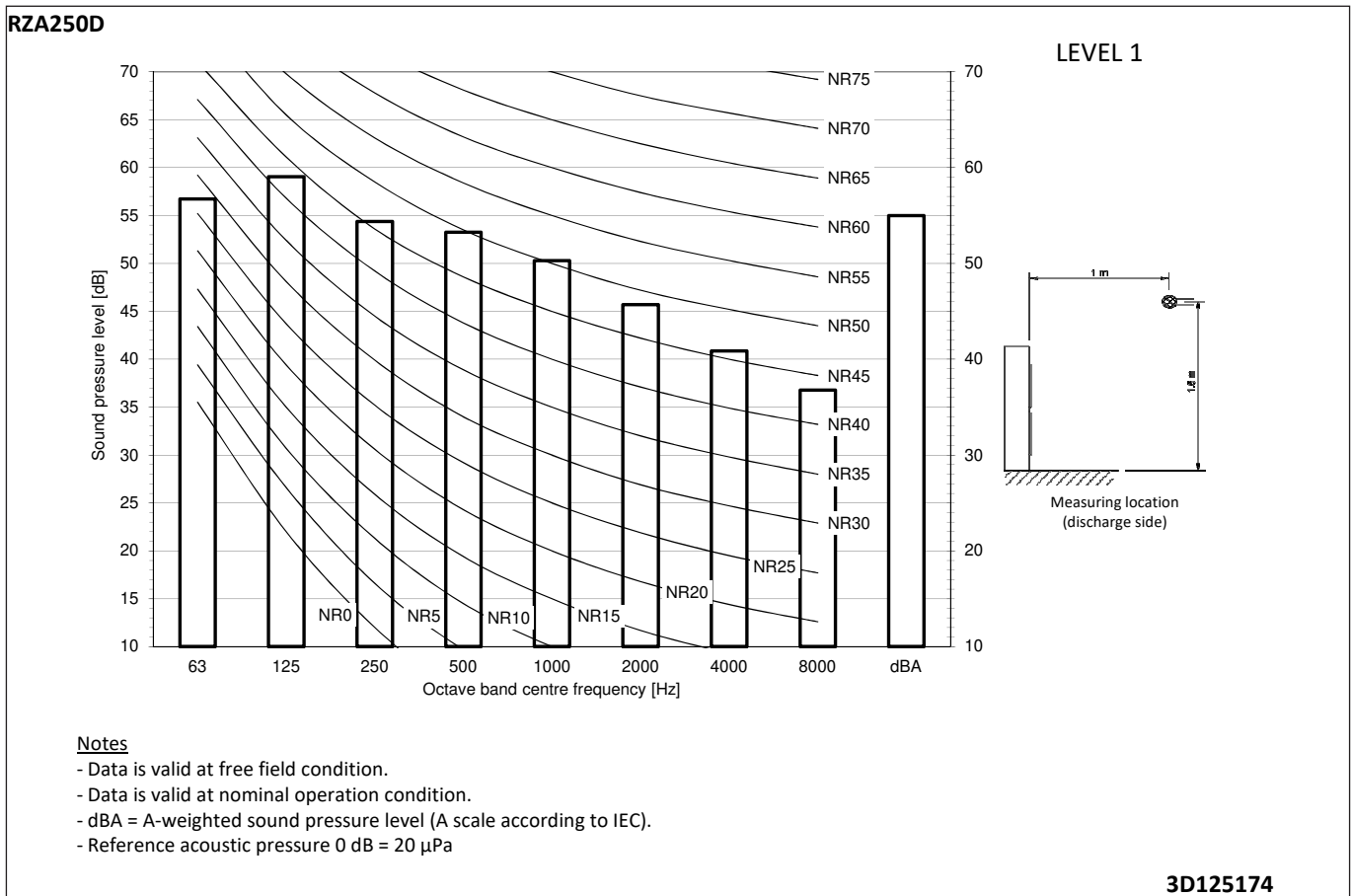
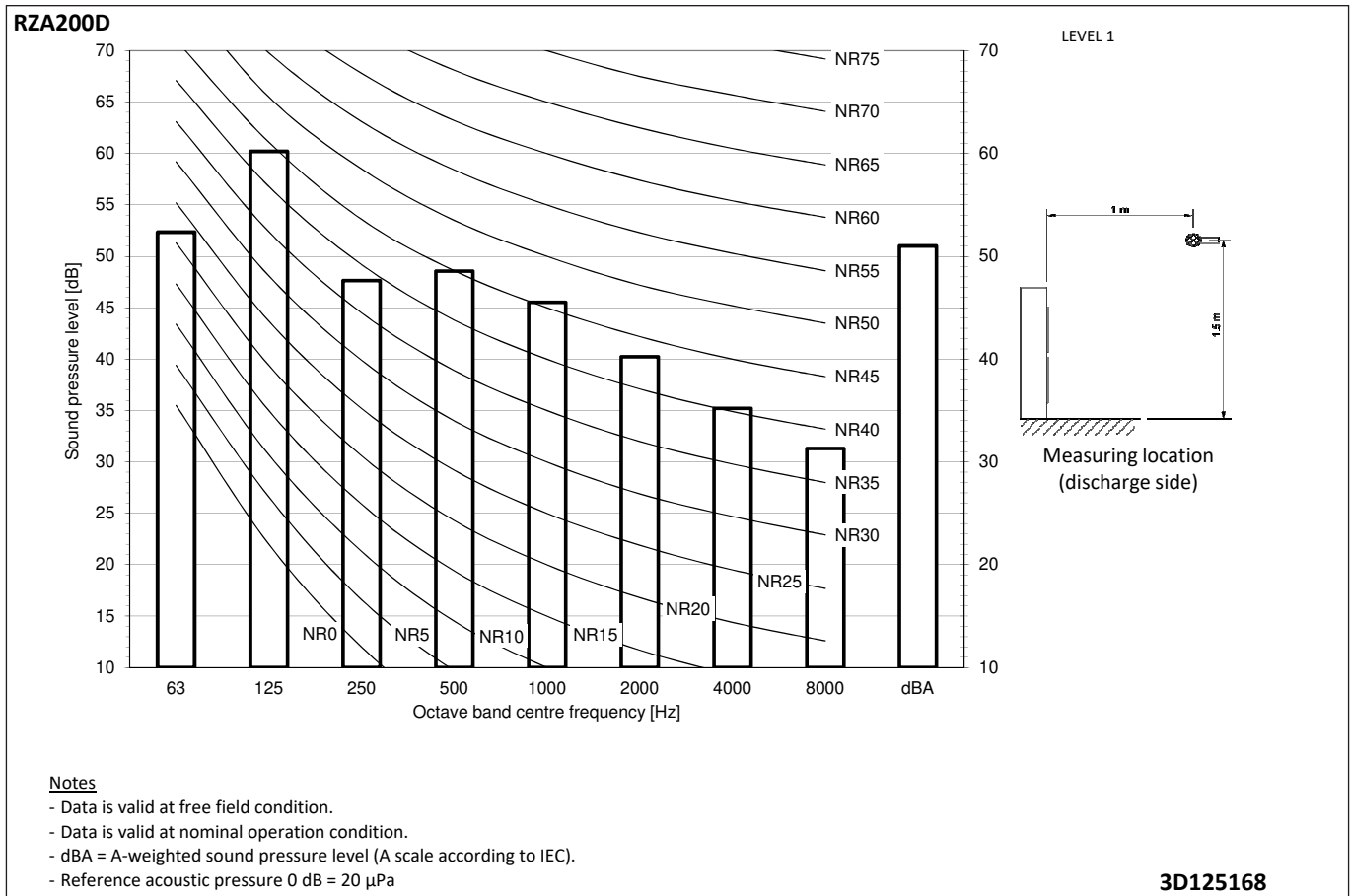

11 Sound data

11 - 5 Sound Pressure Spectrum Quiet Mode Level 2

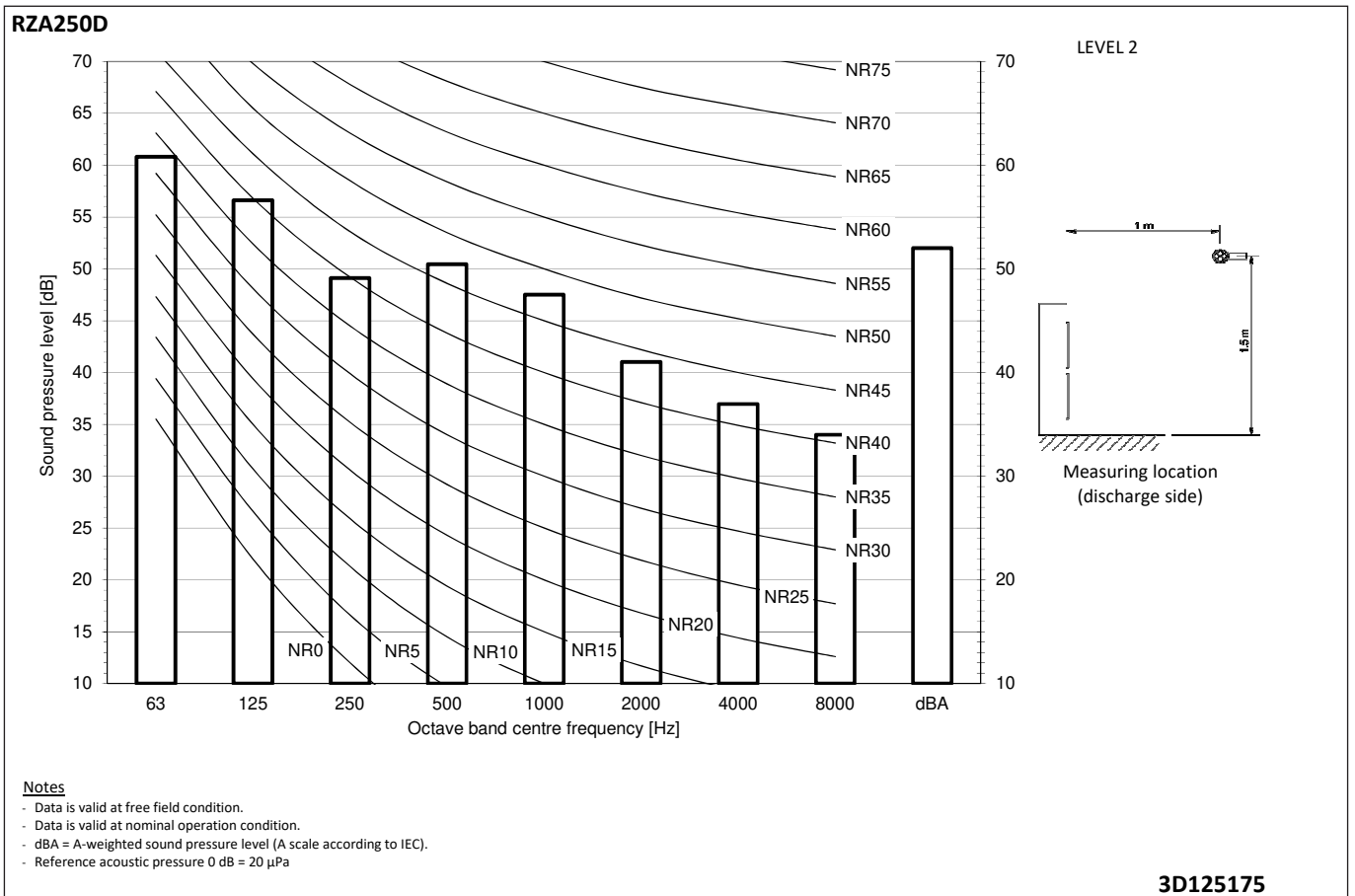
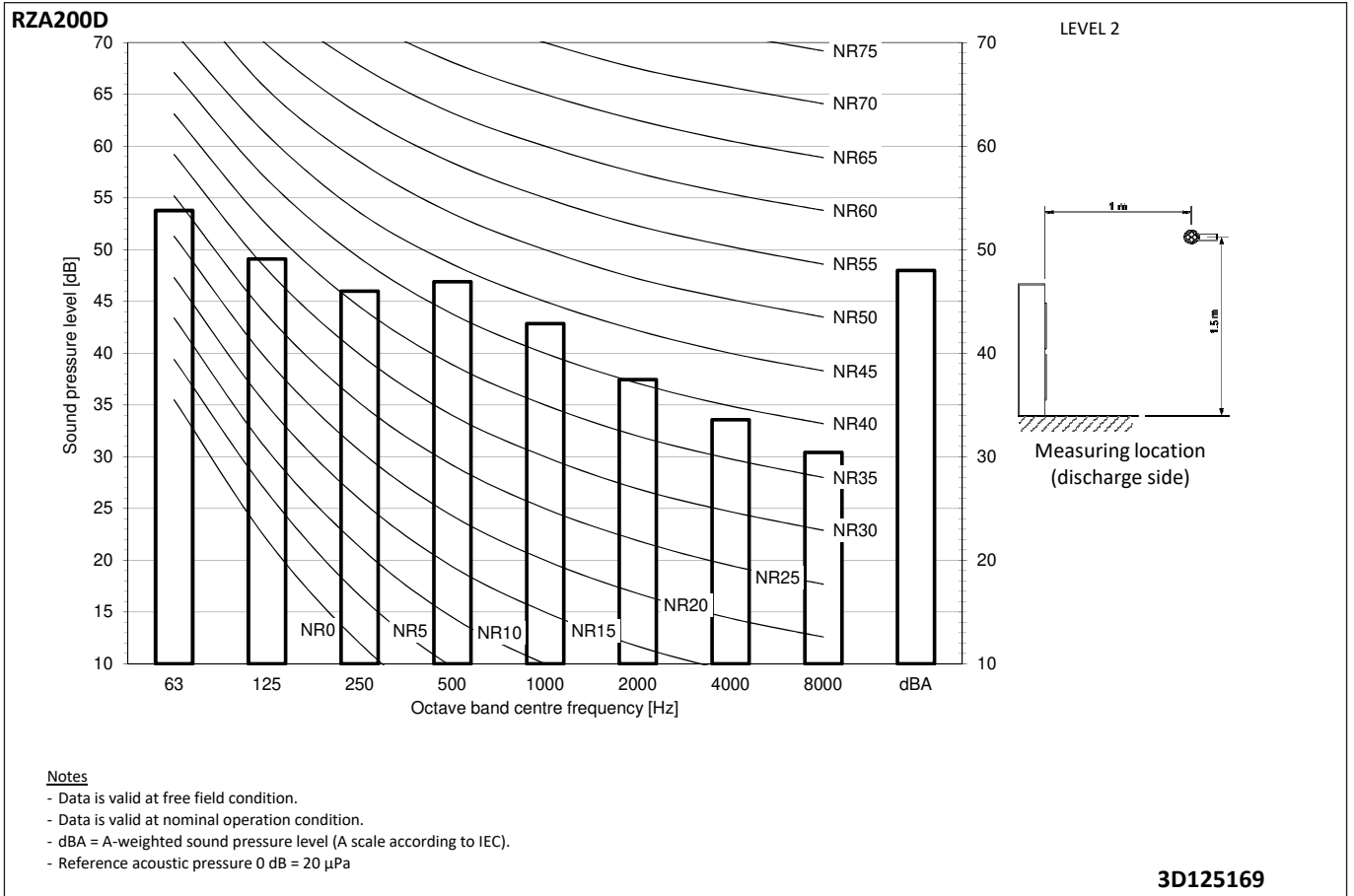

11 Sound data

11 - 6 Sound Pressure Spectrum Quiet Mode Level 3

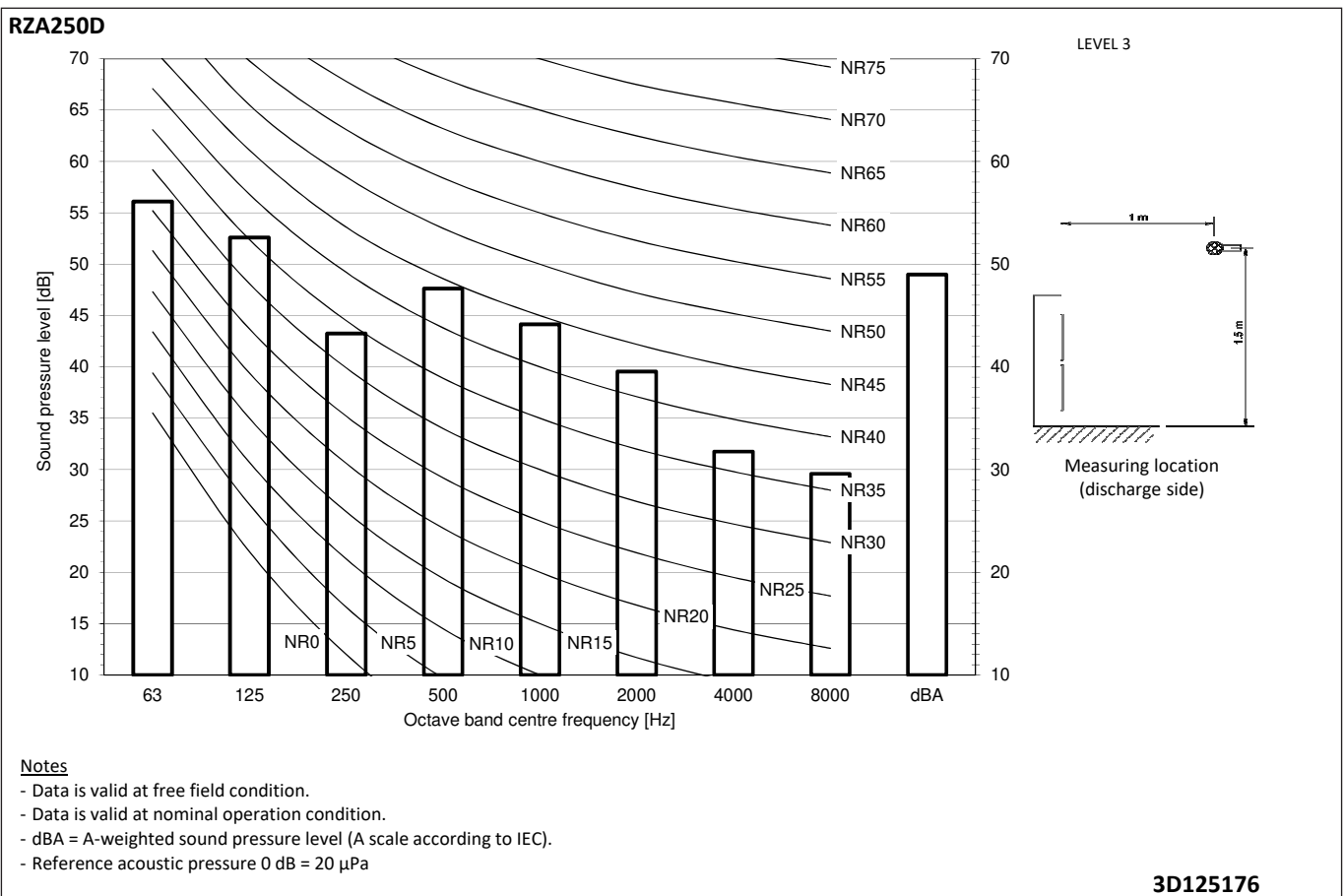
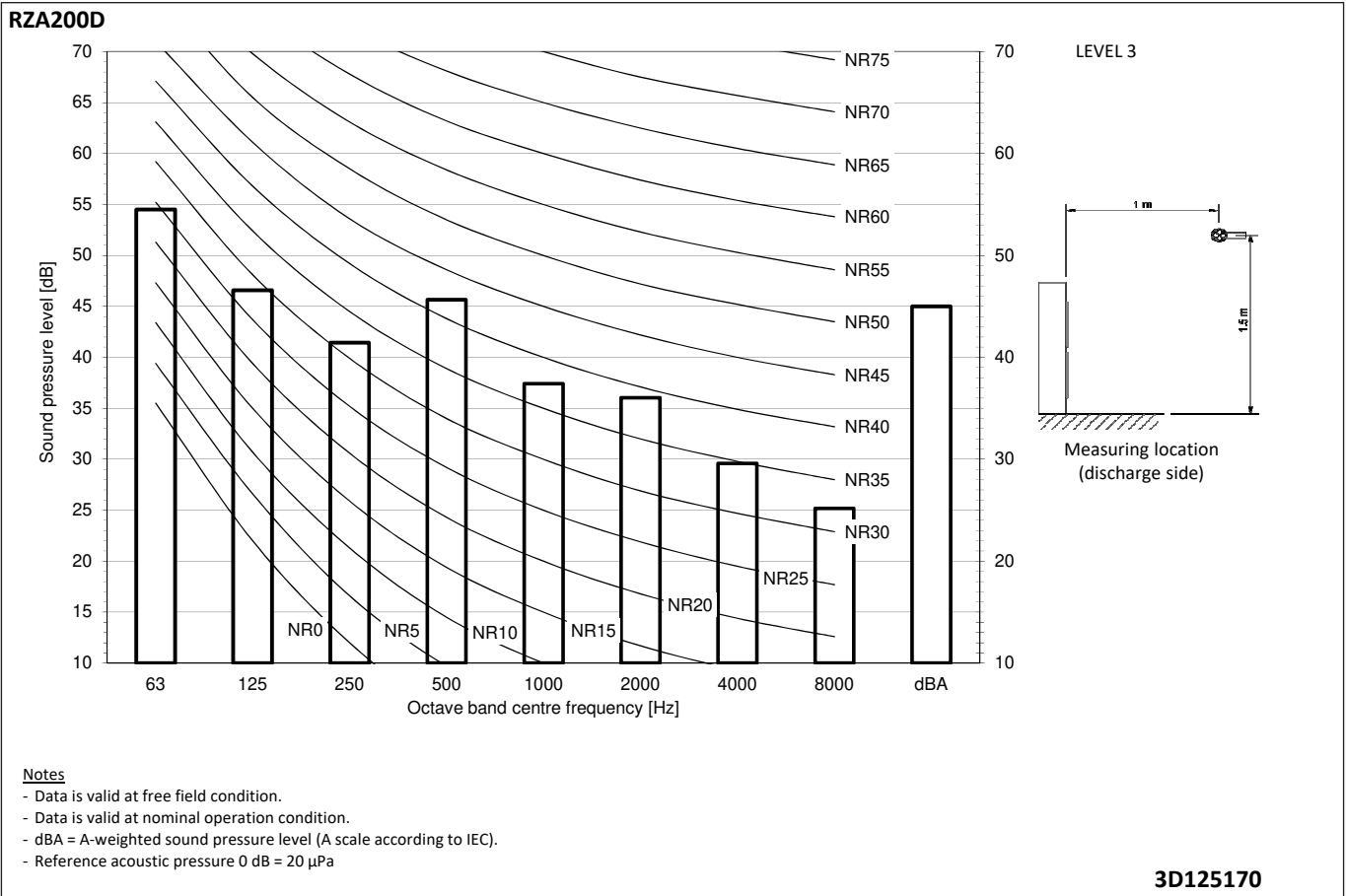

12 Installation

12 - 1 Installation Method

12

RZA-D

Single unit (■) | Single row of units (■ ■ ■)

Suction side

In the illustration below, the service space at the suction side is based on 35°C DB and cooling operation. Foresee more space in the following cases:

- When the suction side temperature regularly exceeds this temperature.
- When the heat load of the outdoor units is expected to regularly exceed the maximum operating capacity.

Discharge side

Take refrigerant piping work into account when positioning the units. If your lay out does not match with any of the layouts below, contact your dealer.

Single unit (■) | Single row of units (■ ■ ■)

	A-E	Hb Hd Hu	(mm)									
			a	b	c	d	e	e _B		e _D		
	B	-		≥ 100								
	A,B,C	-	≥ 100(1)	≥ 100	≥ 100							
	B,E	-		≥ 100			≥ 1000		≤500			
	A,B,C,E	-	≥ 150(1)	≥ 150	≥ 150		≥ 1000		≤500			
	D	-					≥ 500					
	D,E	-					≥ 500	≥ 1000	≤500			
	B,D	Hd>Hu			≥ 100		≥ 500					
		Hd≤Hu			≥ 100		≥ 500					
	B,D,E	Hd>Hu	Hb≤½Hu		≥ 250		≥ 750	≥ 1000	≤500			1
			½Hu>Hb≤Hu		≥ 250		≥ 1000	≥ 1000	≤500			
Hb>Hu					⊘							
Hd≤Hu		Hd≤½Hu		≥ 100		≥ 1000	≥ 1000	≤500				
		½Hu<Hd≤Hu		≥ 200		≥ 1000	≥ 1000	≤500				
Hd>Hu							⊘					
	A,B,C	-	≥ 200(1)	≥ 300	≥ 1000							
	A,B,C,E	-	≥ 200(1)	≥ 300	≥ 1000		≥ 1000		≤500			
	D	-					≥ 1000					
	D,E	-					≥ 1000	≥ 1000	≤500			
	B,D	Hd>Hu			≥ 300		≥ 1000					1+2
		Hd≤Hu	Hd≤½Hu		≥ 250		≥ 1500					
			½Hu<Hd≤Hu		≥ 300		≥ 1500					
	B,D,E	Hd>Hu	Hb≤½Hu		≥ 300		≥ 1000	≥ 1000	≤500			
			½Hu<Hb≤Hu		≥ 300		≥ 1250	≥ 1000	≤500			
		Hb>Hu					⊘					
Hd≤Hu		Hd≤½Hu		≥ 250		≥ 1500	≥ 1000	≤500				
	½Hu<Hd≤Hu		≥ 300		≥ 1500	≥ 1000	≤500					
Hd>Hu								⊘				

(1) For better serviceability, use a distance ≥250 mm

A,B,C,D Obstacles (walls/baffle plates)

E Obstacle (roof)

a,b,c,d,e Minimum service space between the unit and obstacles A, B, C, D and E

e_B Maximum distance between the unit and the edge of obstacle E, in the direction of obstacle B

e_D Maximum distance between the unit and the edge of obstacle E, in the direction of obstacle D

Hu Height of the unit

Hb,Hd Height of obstacles B and D

1 Seal the bottom of the installation frame to prevent discharged air from flowing back to the suction side through the bottom of the unit.

2 Maximum two units can be installed.

⊘ Not allowed

1D128513

12 Installation

12 - 1 Installation Method

RZA-D

Multiple rows of units ()

Multiple rows of units ()

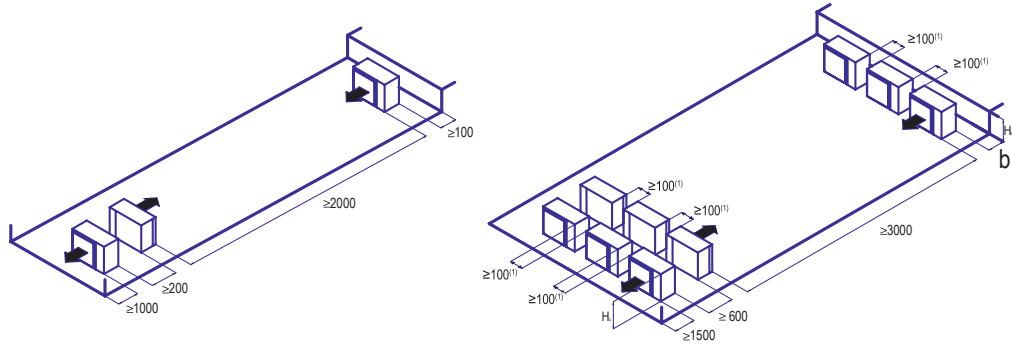

Hb Hu	b (mm)
$Hb \leq \frac{1}{2}Hu$	$b \geq 250$
$\frac{1}{2}Hu < Hb \leq Hu$	$b \geq 300$
$Hb > Hu$	⊘

(1) For better serviceability, use a distance ≥ 250 mm

⊘ Not allowed

1D128513

12 Installation

12 - 1 Installation Method

12

RZA-D

Stacked units (max.2 levels) 

Stacked units (max.2 levels) 

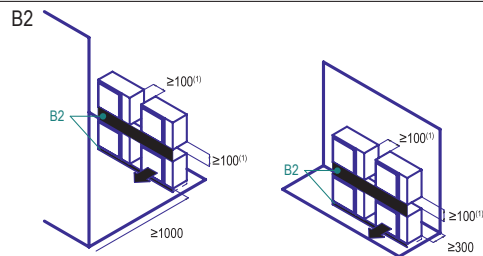
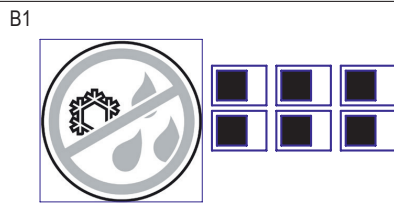
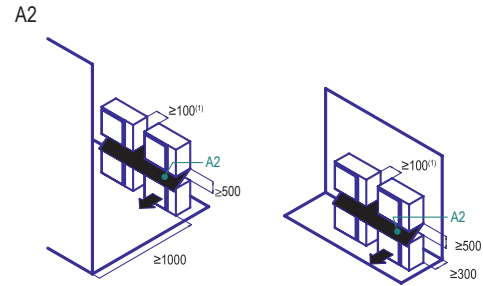
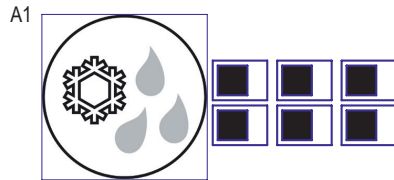

- (1) For better serviceability, use a distance ≥ 250 mm
- A1=>A2 (A1) If there is danger of drainage dripping and freezing between the upper and lower units...
- (A2) Then install a roof between the upper and lower units. Install the upper unit high enough above the lower unit to prevent ice buildup at the upper unit's bottom plate.
- B1=>B2 (B1) If there is no danger of drainage dripping and freezing between the upper and lower units...
- (B2) Then it is not required to install a roof, but seal the gap between the upper and lower units to prevent discharged air from flowing back to the suction side through the bottom of the unit.

1D128513

12 Installation

12 - 2 Service Space

RZA-D

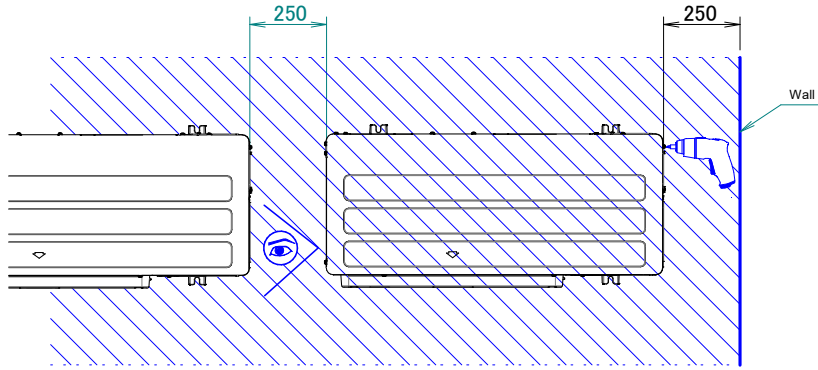

* For optimal serviceability, provide ≥ 250 mm of free space.
 For more installation and service space guidelines, see drawing ·3D069554·.

3D120935

13 Operation range

13 - 1 Operation Range

13

RZA-D

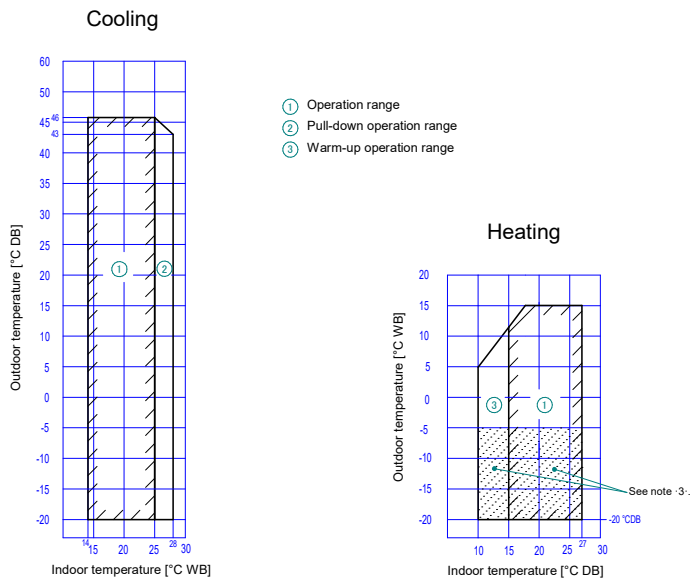

Notes

1. Depending on operation and installation conditions, the indoor unit can change over to freeze-up operation (indoor de-icing).
2. To reduce the freeze-up operation (indoor de-icing) frequency, it is recommended to install the outdoor unit in a location not exposed to wind.
3. If the unit is selected to operate at ambient temperature < -5°C for 3 days or more, with relative humidity of 100%, it is required to install the optional bottom plate heater.

3D120938

14 Appropriate Indoors

14 - 1 Appropriate Indoors

RZA-D

ENER Lot 21 Recommended combinations

Sky Air	Duct (high ESP)		Thin cassette		Duct (medium ESP)	
	FDA200	FDA250	FCAG60	FCAG60	FDA50	FBA60
RZA200D7Y1B	P		4		4	
RZA250D7Y1B		P		4		4

Appropriate indoor units

Connectable to ·RZA200D7Y1B· and covered by ·ENER Lot 21·

FDA200	FCAG60	FFA60	FBA60	FHA60	FUA71	FAA71	FVA71	FDXM60	FNA60
-	FCAG60	FFA60	FBA60	FHA60	FUA100	FAA100	FVA100	FDXM60	FNA60
-	FCAG71	-	FBA71	FHA71	-	-	-	-	-
-	FCAG100	-	FBA100	FHA100	-	-	-	-	-

Connectable to ·RZA250D7Y1B· and covered by ·ENER Lot 21·

FDA250	FCAG60	FFA60	FBA60	FHA60	FUA125	FDA125	FVA125	FDXM60	FNA60
-	FCAG125	-	FBA125	FHA125	-	-	-	-	-

3D120940

Daikin Europe N.V. Naamloze Vennootschap · Zandvoordestraat 300 · 8400 Oostende · Belgium · www.daikin.eu · BE 0412 120 336 · RPR Oostende (Responsible Editor)

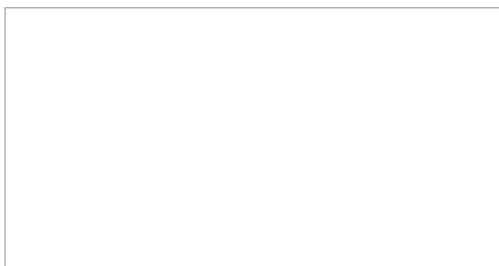

Daikin Europe N.V. participates in the Eurovent Certified Performance programme for Fan Coil Units and Variable Refrigerant Flow systems. Check ongoing validity of certificate: www.eurovent-certification.com

EEDEN21

10/2021



The present leaflet is drawn up by way of information only and does not constitute an offer binding upon Daikin Europe N.V. Daikin Europe N.V. has compiled the content of this leaflet to the best of its knowledge. No express or implied warranty is given for the completeness, accuracy, reliability or fitness for particular purpose of its content and the products and services presented therein. Specifications are subject to change without prior notice. Daikin Europe N.V. explicitly rejects any liability for any direct or indirect damage, in the broadest sense, arising from or related to the use and/or interpretation of this leaflet. All content is copyrighted by Daikin Europe N.V.