

Service Manual

Air Conditioner

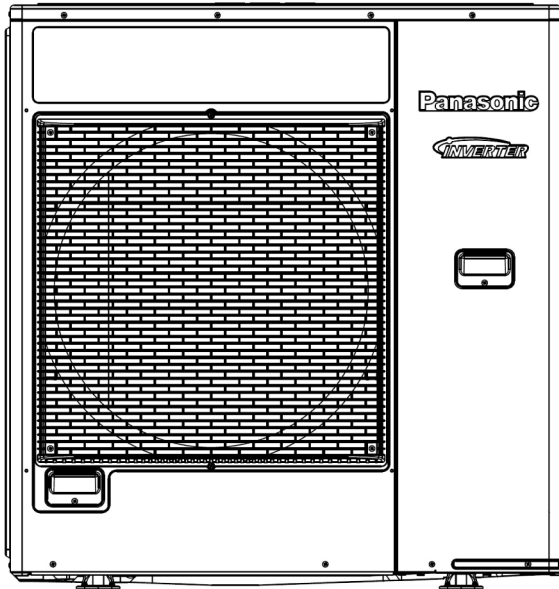

Outdoor Unit
CU-4E27PBD
CU-5E34PBD

Destination
Russia
Ukraine
Belarus
Kazakhstan
Hong Kong

Please file and use this manual together with the service manual for Model No. CS-E7PKDW CS-E9PKDW CS-E12PKDW CS-E15PKDW CS-E18PKDW CS-E24PKDW CS-E10JD3EA CS-E15JD3EA CS-E18JD3EA CS-E10HB4EA CS-E15HB4EA CS-E18HB4EA CS-ME10DTEG CS-E15DTEW CS-E18DTEW CS-E21JB4EA, Order No. PAPAMY1302030CE PHAAM0901093C8 MAC0803024C8 RAC0503011C2 RAC0602011C2 PHAAM0901079C8

WARNING

This service information is designed for experienced repair technicians only and is not designed for use by the general public. It does not contain warnings or cautions to advise non-technical individuals of potential dangers in attempting to service a product. Products powered by electricity should be serviced or repaired only by experienced professional technicians. Any attempt to service or repair the product or products dealt with in this service information by anyone else could result in serious injury or death.

IMPORTANT SAFETY NOTICE

There are special components used in this equipment which are important for safety. These parts are marked by  in the Schematic Diagrams, Circuit Board Diagrams, Exploded Views and Replacement Parts List. It is essential that these critical parts should be replaced with manufacturer's specified parts to prevent shock, fire or other hazards. Do not modify the original design without permission of manufacturer.

PRECAUTION OF LOW TEMPERATURE

In order to avoid frostbite, be assured of no refrigerant leakage during the installation or repairing of refrigerant circuit.



Panasonic®

TABLE OF CONTENTS

	PAGE		PAGE
1. Safety Precautions	3	13.9 Time Delay Safety Control (Restart Control)	36
2. Specifications	5	13.10 30 seconds Force Operation	36
2.1 CU-4E27PBD	5	13.11 Total Current Control	36
2.2 CU-5E34PBD	7	13.12 IPM (power transistor) Protection Control	36
3. Dimensions	13	13.13 Compressor Protection Control (Gas leak detection control 1)	37
4. Refrigeration Cycle Diagram	14	13.14 Compressor Protection Control (Gas leak detection control 2)	37
4.1 CU-4E27PBD	14	13.15 Valve Close Detection Control	37
4.2 CU-5E34PBD	15	13.16 Compressor Discharge High Pressure Protection Control	37
5. Block Diagram	16	14. Servicing Mode	38
5.1 CU-4E27PBD	16	15. Troubleshooting Guide	40
5.2 CU-5E34PBD	17	15.1 Self Diagnosis Function	40
6. Wiring Connection Diagram	18	16. Disassembly and Assembly Instructions	43
6.1 CU-4E27PBD	18	16.1 Outdoor Unit Removal Procedure	43
6.2 CU-5E34PBD	19	17. Technical Data	46
7. Electronic Circuit Diagram	20	17.1 Operation Characteristics	46
7.1 CU-4E27PBD	20	18. Exploded View and Replacement Parts List	58
7.2 CU-5E34PBD	21		
8. Printed Circuit Board	22		
8.1 Main Printed Circuit Board	22		
8.2 Noise Filter Printed Circuit Board	23		
8.3 Display Printed Circuit Board	23		
9. Installation Information	24		
9.1 CU-4E27PBD	24		
9.2 CU-5E34PBD	25		
10. Installation Instruction	26		
10.1 Select The Best Location	26		
10.2 Install The Outdoor Unit	27		
10.3 Connect The Piping	27		
10.4 Evacuation Of The Equipment	28		
10.5 Connect The Cable To The Outdoor Unit	29		
10.6 Heat Insulation	30		
10.7 Disposal Of Outdoor Unit Drain Water	30		
11. Operation Control	31		
11.1 Cooling Operation	31		
11.2 Heating Operation	32		
12. Simultaneous Operation Control	33		
13. Protection Control	34		
13.1 Freeze Prevention Control (Cool)	34		
13.2 Dew Prevention Control (Cool)	34		
13.3 Electronic Parts Temperature Rise Protection 1 (Cool)	34		
13.4 Electronic Parts Temperature Rise Protection 2 (Cool)	34		
13.5 Cooling Overload Control (Cool)	35		
13.6 Heating Overload Control (Heat)	35		
13.7 Extreme Low Temperature Compressor Low Pressure Protection Control (Heat)	35		
13.8 Deice Control	36		

1. Safety Precautions





- Read the following “SAFETY PRECAUTIONS” carefully before perform any servicing.
- Electrical work must be installed or serviced by a licensed electrician. Be sure to use the correct rating of the power plug and main circuit for the model installed.
- The caution items stated here must be followed because these important contents are related to safety. The meaning of each indication used is as below. Incorrect installation or servicing due to ignoring of the instruction will cause harm or damage, and the seriousness is classified by the following indications.

 WARNING	This indication shows the possibility of causing death or serious injury.
 CAUTION	This indication shows the possibility of causing injury or damage to properties.

- The items to be followed are classified by the symbols:

	This symbol denotes item that is PROHIBITED from doing.
---	---

- Carry out test run to confirm that no abnormality occurs after the servicing. Then, explain to user the operation, care and maintenance as stated in instructions. Please remind the customer to keep the operating instructions for future reference.

 WARNING	
1. Do not modify the machine, part, material during repairing service.	
2. If wiring unit is supplied as repairing part, do not repair or connect the wire even only partial wire break. Exchange the whole wiring unit.	
3. Do not wrench the fasten terminal. Pull it out or insert it straightly.	
4. Engage dealer or specialist for installation and servicing. If installation or servicing done by the user is defective, it will cause water leakage, electrical shock or fire.	
5. Install according to this installation instructions strictly. If installation is defective, it will cause water leakage, electric shock or fire.	
6. Use the attached accessories parts and specified parts for installation and servicing. Otherwise, it will cause the set to fall, water leakage, fire or electrical shock.	
7. Install at a strong and firm location which is able to withstand the set's weight. If the strength is not enough or installation is not properly done, the set will drop and cause injury.	
8. For electrical work, follow the local national wiring standard, regulation and the installation instruction. An independent circuit and single outlet must be used. If electrical circuit capacity is not enough or defect found in electrical work, it will cause electrical shock or fire.	
9. This equipment is strongly recommended to install with Earth Leakage Circuit Breaker (ELCB) or Residual Current Device (RCD). Otherwise, it may cause electrical shock and fire in case equipment breakdown or insulation breakdown.	
10. Do not use joint cable for indoor/outdoor connection cable. Use the specified indoor/outdoor connection cable, refer to Installation Instruction CONNECT THE CABLE TO THE INDOOR UNIT and connect tightly for indoor/outdoor connection. Clamp the cable so that no external force will be acted on the terminal. If connecting or fixing is not perfect, it will cause heat up or fire at the connection.	
11. Wire routing must be properly arranged so that control board cover is fixed properly. If control board cover is not fixed perfectly, it will cause heat-up or fire at the connection point of terminal, fire or electrical shock.	
12. When install or relocate air conditioner, do not let any substance other than the specified refrigerant, eg. air etc. mix into refrigeration cycle (piping). (Mixing of air etc. will cause abnormal high pressure in refrigeration cycle and result in explosion, injury etc.)	
13. Do not install outdoor unit near handrail of veranda. When installing air-conditioner unit at veranda of high rise building, child may climb up to outdoor unit and cross over the handrail and causing accident.	
14. This equipment must be properly earthed. Earth line must not be connected to gas pipe, water pipe, earth of lightning rod and telephone. Otherwise, it may cause electric shock in case equipment breakdown or insulation breakdown.	
15. Keep away from small children, the thin film may cling to nose and mouth and prevent breathing.	
16. Do not use unspecified cord, modified cord, joint cord or extension cord for power supply cord. Do not share the single outlet with other electrical appliances. Poor contact, poor insulation or over current will cause electrical shock or fire.	
17. Tighten the flare nut with torque wrench according to specified method. If the flare nut is over-tightened, after a long period, the flare may break and cause refrigerant gas leakage.	

18. For R410A models, when connecting the piping, do not use any existing (R22) pipes and flare nuts. Using such same may cause abnormally high pressure in the refrigeration cycle (piping), and possibly result in explosion and injury. Use only R410A materials. Thickness of copper pipes used with R410A must be more than 0.8mm. Never use copper pipes thinner than 0.8mm. It is desirable that the amount of residual oil is less than 40 mg/10m.	⊘
19. During installation, install the refrigerant piping properly before run the compressor. (Operation of compressor without fixing refrigeration piping and valves at opened condition will cause suck-in of air, abnormal high pressure in refrigeration cycle and result in explosion, injury etc.).	
20. During pump down operation, stop the compressor before remove the refrigeration piping. (Removal of refrigeration piping while compressor is operating and valves are opened condition will cause suck-in of air, abnormal high pressure in refrigeration cycle and result in explosion, injury etc.).	
21. After completion of installation or service, confirm there is no leakage or refrigerant gas. It may generate toxic gas when the refrigerant contacts with fire.	
22. Ventilate if there is refrigerant gas leakage during operation. It may cause toxic gas when refrigerant contacts with fire.	
23. Do not insert your fingers or other objects into the unit, high speed rotating fan may cause injury.	⊘
24. Must not use other parts except original parts described in catalog and manual.	
25. Using of refrigerant other than the specified type may cause product damage, burst and injury etc.	

 **CAUTION**

1. Do not install the unit at place where leakage of flammable gas may occur. In case gas leaks and accumulates at surrounding of the unit, it may cause fire.	⊘
2. Carry out drainage piping as mentioned in installation instructions. If drainage is not perfect, water may enter the room and damage the furniture.	
3. Tighten the flare nut with torque wrench according to specified method. If the flare nut is over-tightened, after a long period, the flare may break and cause refrigerant gas leakage.	
4. Do not touch outdoor unit air inlet and aluminium fin. It may cause injury.	⊘
5. Select an installation location which is easy for maintenance.	
6. Pb free solder has a higher melting point than standard solder; typically the melting point is 50°F – 70°F (30°C – 40°C) higher. Please use a high temperature solder iron. In case of the soldering iron with temperature control, please set it to 700 ± 20°F (370 ± 10°C). Pb free solder will tend to splash when heated too high (about 1100°F / 600°C).	
7. Power supply connection to the room air conditioner. Use power supply cord CU-4E27*** (3 x 2.5 mm ²), CU-5E34*** (3 x 4.0 mm ²) type designation 245 IEC 57 or heavier cord. Connect the power supply cord of the air conditioner to the mains using one of the following method. Power supply point should be in easily accessible place for power disconnection in case of emergency. In some countries, permanent connection of this air conditioner to the power supply is prohibited. i. Power supply connection to the receptacle using power plug. Use an approved 20A (CU-4E27***), 25A (CU-5E34***) power plug with earth pin for the connection to the socket. ii. Power supply connection to a circuit breaker for the permanent connection. Use an approved 20A (CU-4E27***), 25A (CU-5E34***) circuit breaker for the permanent connection. It must be a double pole switch with a minimum 3.0 mm contact gap.	
8. Do not release refrigerant during piping work for installation, servicing, reinstallation and during repairing a refrigerant parts. Take care of the liquid refrigerant, it may cause frostbite.	⊘
9. Installation or servicing work: It may need two people to carry out the installation or servicing work.	
10. Do not install this appliance in a laundry room or other location where water may drip from the ceiling, etc.	⊘
11. Do not sit or step on the unit, you may fall down accidentally.	⊘
12. Do not touch the sharp aluminum fins or edges of metal parts. If you are required to handle sharp parts during installation or servicing, please wear hand glove. Sharp parts may cause injury.	⊘

2. Specifications

2.1 CU-4E27PBD

Item		Unit	OUTDOOR UNIT	
Indoor Unit Combination			2.2kW + 2.2kW + 2.2kW + 7.0kW	
Power Source			1 Phase, 230V, 50Hz (Power supply from outdoor unit)	
Cooling Operation	Capacity		kW	8.0 (3.0 ~ 9.2)
			BTU/h	27300 (10200 ~ 31400)
	Electrical Data	Running Current	A	9.4
		Power Input	kW	1.98 (0.53 ~ 2.87)
		EER	W/W	4.04 (5.66 ~ 3.21)
	Noise	Sound Pressure Level	dB-A (H/L)	51 / -
Sound Power Level		dB (H/L)	67 / -	
Heating Operation	Capacity		kW	9.4 (4.2 ~ 10.6)
			BTU/h	32100 (14300 ~ 36100)
	Electrical Data	Running Current	A	9.8
		Power Input	kW	2.08 (0.70 ~ 3.06)
		COP	W/W	4.52 (6.00 ~ 3.46)
	Noise	Sound Pressure Level	dB-A (H/L)	52 / -
Sound Power Level		dB (H/L)	68 / -	
Maximum Current		A	19.0	
Starting Current		A	9.8	
Circuit Breaker Capacity		A	20	
Dimension	Height	mm	999	
	Width	mm	940	
	Depth	mm	340	
Net Weight		kg	80	
Connection Cable			3 + 1 (Earth) ϕ 1.5 mm ²	
Pipe Length Range (1 room)		m	3 ~ 25	
Maximum Pipe Length (Total Room)		m	70	
Refrigerant Pipe Diameter	Liquid Side	mm (inch)	6.35 (1/4)	
	Gas Side	mm (inch)	9.52 (3/8) (E21 & E24:12.7 (1/2))	
Compressor	Type		Hermetic Motor / Rotary	
	Motor Type		Brushless (4-poles)	
	Rated Output	W	1.70k	
Air Circulation	Type		Propeller Fan	
	Motor Type		DC Motor (8-poles)	
	Rated Output	W	90	
Fan Speed	High (Cooling / Heating)	RPM	550 / 600	
Heat Exchanger	Type		Plate fin configuration forced draft type	
	Tube Material		Copper	
	Fin Material		Aluminum (Pre Coat)	
	Row / Stage		2 / 46	
	FPI		19	
Air Volume	High (Cooling / Heating)	m ³ /min	50.4 / 55.6	
Refrigerant Control Device			Expansion Valve	
Refrigerant Oil			FV50S	
Refrigerant (R410A)		g	3.40k	

Item			Unit	OUTDOOR UNIT	
				Dry Bulb	Wet Bulb
Indoor Operation Range	Cooling	Maximum	°C	32	23
		Minimum	°C	16	11
	Heating	Maximum	°C	30	—
		Minimum	°C	16	—
Outdoor Operation Range	Cooling	Maximum	°C	46	26
		Minimum	°C	-10	—
	Heating	Maximum	°C	24	18
		Minimum	°C	-15	-16

Note

- Specifications are subject to change without notice for further improvement.

2.2 CU-5E34PBD

Item		Unit	OUTDOOR UNIT	
Indoor Unit Combination			2.2kW + 2.2kW + 2.8kW + 3.2kW + 7.0kW	
Power Source			1 Phase, 230V, 50Hz (Power supply from outdoor unit)	
Cooling Operation	Capacity		kW	10.0 (2.9 ~ 11.5)
			BTU/h	34100 (9890 ~ 39200)
	Electrical Data	Running Current	A	13.2
		Power Input	kW	2.86 (0.55 ~ 3.86)
		EER	W/W	3.50 (5.27 ~ 2.98)
	Noise	Sound Pressure Level	dB-A (H/L)	53 / -
Sound Power Level		dB (H/L)	69 / -	
Heating Operation	Capacity		kW	12.0 (3.4 ~ 14.5)
			BTU/h	40900 (11600 ~ 49400)
	Electrical Data	Running Current	A	13.4
		Power Input	kW	2.86 (0.53 ~ 4.24)
		COP	W/W	4.20 (6.42 ~ 3.42)
	Noise	Sound Pressure Level	dB-A (H/L)	54 / -
Sound Power Level		dB (H/L)	70 / -	
Maximum Current		A	21.3	
Starting Current		A	13.4	
Circuit Breaker Capacity		A	25	
Dimension	Height	mm	999	
	Width	mm	940	
	Depth	mm	340	
Net Weight		kg	81	
Connection Cable			3 + 1 (Earth) ϕ 1.5 mm ²	
Pipe Length Range (1 room)		m	3 ~ 25	
Maximum Pipe Length (Total Room)		m	80	
Refrigerant Pipe Diameter	Liquid Side	mm (inch)	6.35 (1/4)	
	Gas Side	mm (inch)	9.52 (3/8) (E21 & E24:12.7(1/2))	
Compressor	Type		Hermetic Motor / Rotary	
	Motor Type		Brushless (4-poles)	
	Rated Output	W	1.70k	
Air Circulation	Type		Propeller Fan	
	Motor Type		DC Motor (8-poles)	
	Rated Output	W	90	
Fan Speed	High (Cooling / Heating)	RPM	650 / 740	
Heat Exchanger	Type		Plate fin configuration forced draft type	
	Tube Material		Copper	
	Fin Material		Aluminum (Pre Coat)	
	Row / Stage		2 / 46	
	FPI		19	
Air Volume	High (Cooling / Heating)	m ³ /min	60.8 / 70.1	
Refrigerant Control Device			Expansion Valve	
Refrigerant Oil			FV50S	
Refrigerant (R410A)		g	3.40k	

Item			Unit	OUTDOOR UNIT	
				Dry Bulb	Wet Bulb
Indoor Operation Range	Cooling	Maximum	°C	32	23
		Minimum	°C	16	11
	Heating	Maximum	°C	30	—
		Minimum	°C	16	—
Outdoor Operation Range	Cooling	Maximum	°C	46	26
		Minimum	°C	-10	—
	Heating	Maximum	°C	24	18
		Minimum	°C	-15	-16

Note

- Specifications are subject to change without notice for further improvement.

- **Multi Split Combination Possibility:**

- A single outdoor unit enables air conditioning of up to four separate rooms for CU-4E27PBD.
- A single outdoor unit enables air conditioning of up to five separate rooms for CU-5E34PBD.

CONNECTABLE INDOOR UNIT			OUTDOOR UNIT									
			CU-4E27PBD				CU-5E34PBD					
Type	ROOM		A	B	C	D	A	B	C	D	E	
Wall	2.2kW	CS-E7PKDW	●	●	●	●	●	●	●	●	●	
	2.8kW	CS-E9PKDW	●	●	●	●	●	●	●	●	●	
		CS-E10JD3EA	●	●	●	●	●	●	●	●	●	
		CS-E10HB4EA	●	●	●	●	●	●	●	●	●	
		CS-ME10DTEG	●	●	●	●	●	●	●	●	●	
	3.2kW	CS-E12PKDW	●	●	●	●	●	●	●	●	●	
	4.0kW	CS-E15PKDW	●	●	●	●	●	●	●	●	●	
CS-E15JD3EA		●	●	●	●	●	●	●	●	●		
CS-E15HB4EA		●	●	●	●	●	●	●	●	●		
CS-E15DTEW		●	●	●	●	●	●	●	●	●		
5.0kW	CS-E18PKDW	●	●	●	●	●	●	●	●	●		
	CS-E18JD3EA	●	●	●	●	●	●	●	●	●		
	CS-E18HB4EA	●	●	●	●	●	●	●	●	●		
	CS-E18DTEW	●	●	●	●	●	●	●	●	●		
6.0kW	CS-E21JB4EA	●	●	●	●	●	●	●	●	●		
7.0kW	CS-E24PKDW	●	●	●	●	●	●	●	●	●		
Capacity range of connectable indoor units			From 5.0kW to 13.6kW				From 5.0kW to 17.4kW					
Pipe length	1-room maximum pipe length (m)		25				25					
	Allowable elevation (m)		15				15					
	Total allowable pipe length (m)		70				80					
	Total pipe length for maximum chargeless length (m)		45				45					
	Additional gas amount over chargeless length (g/m)		20				20					
Note: "●": Available												
Remarks for CU-4E27PBD / CU-5E34PBD 1. At least two indoor units must be connected. 2. The total nominal cooling capacity of indoor units that will be connected to outdoor unit must be within connectable capacity range of indoor unit. (as shown in the table above) Example: The indoor units' combination below is possible to connect to CU-4E27PBD. (Total nominal capacity of indoor units is between 5.0kW to 13.6kW) 1) Two CS-E9PKDW only (Total nominal cooling capacity is 5.6kW) 2) Three CS-E12PKDW. (Total nominal cooling capacity is 9.6kW)												

- Indoor Unit : CS-E7/9/12/15/18/24PKDW, CS-E10/15/18JD3EA, CS-E10/15/18HB4EA, CS-ME10DTEG, CS-E15/18DTEW, CS-E21JB4EA
- Outdoor Unit : CU-4E27PBD

4 Room		3 Room		2 Room		1 Room	
Indoor Unit Capacity (kW)	Total Indoor Capacity (kW)	Indoor Unit Capacity (kW)	Total Indoor Capacity (kW)	Indoor Unit Capacity (kW)	Total Indoor Capacity (kW)	Indoor Unit Capacity (kW)	Total Indoor Capacity (kW)
2.2+2.2+2.2+2.2	8.8	2.2+2.2+2.2	6.6	2.2+2.8	5.0	2.2	2.2
2.2+2.2+2.2+2.8	9.4	2.2+2.2+2.8	7.2	2.2+3.2	5.4	2.8	2.8
2.2+2.2+2.2+3.2	9.8	2.2+2.2+3.2	7.6	2.2+4.0	6.2	3.2	3.2
2.2+2.2+2.2+4.0	10.6	2.2+2.2+4.0	8.4	2.2+5.0	7.2	4.0	4.0
2.2+2.2+2.2+5.0	11.6	2.2+2.2+5.0	9.4	2.2+6.0	8.2	5.0	5.0
2.2+2.2+2.2+6.0	12.6	2.2+2.2+6.0	10.4	2.2+7.0	9.2	6.0	6.0
2.2+2.2+2.2+7.0	13.6	2.2+2.2+7.0	11.4	2.8+2.8	5.6	7.0	7.0
2.2+2.2+2.8+2.8	10.0	2.2+2.8+2.8	7.8	2.8+3.2	6.0		
2.2+2.2+2.8+3.2	10.4	2.2+2.8+3.2	8.2	2.8+4.0	6.8		
2.2+2.2+2.8+4.0	11.2	2.2+2.8+4.0	9.0	2.8+5.0	7.8		
2.2+2.2+2.8+5.0	12.2	2.2+2.8+5.0	10.0	2.8+6.0	8.8		
2.2+2.2+2.8+6.0	13.2	2.2+2.8+6.0	11.0	2.8+7.0	9.8		
2.2+2.2+3.2+3.2	10.8	2.2+2.8+7.0	12.0	3.2+3.2	6.4		
2.2+2.2+3.2+4.0	11.6	2.2+3.2+3.2	8.6	3.2+4.0	7.2		
2.2+2.2+3.2+5.0	12.6	2.2+3.2+4.0	9.4	3.2+5.0	8.2		
2.2+2.2+3.2+6.0	13.6	2.2+3.2+5.0	10.4	3.2+6.0	9.2		
2.2+2.2+4.0+4.0	12.4	2.2+3.2+6.0	11.4	3.2+7.0	10.2		
2.2+2.2+4.0+5.0	13.4	2.2+3.2+7.0	12.4	4.0+4.0	8.0		
2.2+2.8+2.8+2.8	10.6	2.2+4.0+4.0	10.2	4.0+5.0	9.0		
2.2+2.8+2.8+3.2	11.0	2.2+4.0+5.0	11.2	4.0+6.0	10.0		
2.2+2.8+2.8+4.0	11.8	2.2+4.0+6.0	12.2	4.0+7.0	11.0		
2.2+2.8+2.8+5.0	12.8	2.2+4.0+7.0	13.2	5.0+5.0	10.0		
2.2+2.8+3.2+3.2	11.4	2.2+5.0+5.0	12.2	5.0+6.0	11.0		
2.2+2.8+3.2+4.0	12.2	2.2+5.0+6.0	13.2	5.0+7.0	12.0		
2.2+2.8+3.2+5.0	13.2	2.8+2.8+2.8	8.4	6.0+6.0	12.0		
2.2+2.8+4.0+4.0	13.0	2.8+2.8+3.2	8.8	6.0+7.0	13.0		
2.2+3.2+3.2+3.2	11.8	2.8+2.8+4.0	9.6				
2.2+3.2+3.2+4.0	12.6	2.8+2.8+5.0	10.6				
2.2+3.2+3.2+5.0	13.6	2.8+2.8+6.0	11.6				
2.2+3.2+4.0+4.0	13.4	2.8+2.8+7.0	12.6				
2.8+2.8+2.8+2.8	11.2	2.8+3.2+3.2	9.2				
2.8+2.8+2.8+3.2	11.6	2.8+3.2+4.0	10.0				
2.8+2.8+2.8+4.0	12.4	2.8+3.2+5.0	11.0				
2.8+2.8+2.8+5.0	13.4	2.8+3.2+6.0	12.0				
2.8+2.8+3.2+3.2	12.0	2.8+3.2+7.0	13.0				
2.8+2.8+3.2+4.0	12.8	2.8+4.0+4.0	10.8				
2.8+2.8+4.0+4.0	13.6	2.8+4.0+5.0	11.8				
2.8+3.2+3.2+3.2	12.4	2.8+4.0+6.0	12.8				
2.8+3.2+3.2+4.0	13.2	2.8+5.0+5.0	12.8				
3.2+3.2+3.2+3.2	12.8	3.2+3.2+3.2	9.6				
3.2+3.2+3.2+4.0	13.6	3.2+3.2+4.0	10.4				
		3.2+3.2+5.0	11.4				
		3.2+3.2+6.0	12.4				
		3.2+3.2+7.0	13.4				
		3.2+4.0+4.0	11.2				
		3.2+4.0+5.0	12.2				
		3.2+4.0+6.0	13.2				
		3.2+5.0+5.0	13.2				
		4.0+4.0+4.0	12.0				
		4.0+4.0+5.0	13.0				

- Indoor Unit : CS-E7/9/12/15/18/24PKDW, CS-E10/15/18JD3EA, CS-E10/15/18HB4EA, CS-ME10DTEG, CS-E15/18DTEW, CS-E21JB4EA
- Outdoor Unit : CU-5E34PBD

5 Room		4 Room		3 Room		2 Room		1 Room	
Indoor Unit Capacity (kW)	Total Indoor Capacity (kW)	Indoor Unit Capacity (kW)	Total Indoor Capacity (kW)	Indoor Unit Capacity (kW)	Total Indoor Capacity (kW)	Indoor Unit Capacity (kW)	Total Indoor Capacity (kW)	Indoor Unit Capacity (kW)	Total Indoor Capacity (kW)
2.2+2.2+2.2+2.2+2.2	11.0	2.2+2.2+2.2+2.2	8.8	2.2+2.2+2.2	6.6	2.2+2.8	5.0	2.2	2.2
2.2+2.2+2.2+2.2+2.8	11.6	2.2+2.2+2.2+2.8	9.4	2.2+2.2+2.8	7.2	2.2+3.2	5.4	2.8	2.8
2.2+2.2+2.2+2.2+3.2	12.0	2.2+2.2+2.2+3.2	9.8	2.2+2.2+3.2	7.6	2.2+4.0	6.2	3.2	3.2
2.2+2.2+2.2+2.2+4.0	12.8	2.2+2.2+2.2+4.0	10.6	2.2+2.2+4.0	8.4	2.2+5.0	7.2	4.0	4.0
2.2+2.2+2.2+2.2+5.0	13.8	2.2+2.2+2.2+5.0	11.6	2.2+2.2+5.0	9.4	2.2+6.0	8.2	5.0	5.0
2.2+2.2+2.2+2.2+6.0	14.8	2.2+2.2+2.2+6.0	12.6	2.2+2.2+6.0	10.4	2.2+7.0	9.2	6.0	6.0
2.2+2.2+2.2+2.2+7.0	15.8	2.2+2.2+2.2+7.0	13.6	2.2+2.2+7.0	11.4	2.8+2.8	5.6	7.0	7.0
2.2+2.2+2.2+2.8+2.8	12.2	2.2+2.2+2.8+2.8	10.0	2.2+2.8+2.8	7.8	2.8+3.2	6.0		
2.2+2.2+2.2+2.8+3.2	12.6	2.2+2.2+2.8+3.2	10.4	2.2+2.8+3.2	8.2	2.8+4.0	6.8		
2.2+2.2+2.2+2.8+4.0	13.4	2.2+2.2+2.8+4.0	11.2	2.2+2.8+4.0	9.0	2.8+5.0	7.8		
2.2+2.2+2.2+2.8+5.0	14.4	2.2+2.2+2.8+5.0	12.2	2.2+2.8+5.0	10.0	2.8+6.0	8.8		
2.2+2.2+2.2+2.8+6.0	15.4	2.2+2.2+2.8+6.0	13.2	2.2+2.8+6.0	11.0	2.8+7.0	9.8		
2.2+2.2+2.2+2.8+7.0	16.4	2.2+2.2+2.8+7.0	14.2	2.2+2.8+7.0	12.0	3.2+3.2	6.4		
2.2+2.2+2.2+3.2+3.2	13.0	2.2+2.2+3.2+3.2	10.8	2.2+3.2+3.2	8.6	3.2+4.0	7.2		
2.2+2.2+2.2+3.2+4.0	13.8	2.2+2.2+3.2+4.0	11.6	2.2+3.2+4.0	9.4	3.2+5.0	8.2		
2.2+2.2+2.2+3.2+5.0	14.8	2.2+2.2+3.2+5.0	12.6	2.2+3.2+5.0	10.4	3.2+6.0	9.2		
2.2+2.2+2.2+3.2+6.0	15.8	2.2+2.2+3.2+6.0	13.6	2.2+3.2+6.0	11.4	3.2+7.0	10.2		
2.2+2.2+2.2+3.2+7.0	16.8	2.2+2.2+3.2+7.0	14.6	2.2+3.2+7.0	12.4	4.0+4.0	8.0		
2.2+2.2+2.2+4.0+4.0	14.6	2.2+2.2+4.0+4.0	12.4	2.2+4.0+4.0	10.2	4.0+5.0	9.0		
2.2+2.2+2.2+4.0+5.0	15.6	2.2+2.2+4.0+5.0	13.4	2.2+4.0+5.0	11.2	4.0+6.0	10.0		
2.2+2.2+2.2+4.0+6.0	16.6	2.2+2.2+4.0+6.0	14.4	2.2+4.0+6.0	12.2	4.0+7.0	11.0		
2.2+2.2+2.2+5.0+5.0	16.6	2.2+2.2+4.0+7.0	15.4	2.2+4.0+7.0	13.2	5.0+5.0	10.0		
2.2+2.2+2.8+2.8+2.8	12.8	2.2+2.2+5.0+5.0	14.4	2.2+5.0+5.0	12.2	5.0+6.0	11.0		
2.2+2.2+2.8+2.8+3.2	13.2	2.2+2.2+5.0+6.0	15.4	2.2+5.0+6.0	13.2	5.0+7.0	12.0		
2.2+2.2+2.8+2.8+4.0	14.0	2.2+2.2+5.0+7.0	16.4	2.2+5.0+7.0	14.2	6.0+6.0	12.0		
2.2+2.2+2.8+2.8+5.0	15.0	2.2+2.2+6.0+6.0	16.4	2.2+6.0+6.0	14.2	6.0+7.0	13.0		
2.2+2.2+2.8+2.8+6.0	16.0	2.2+2.2+6.0+7.0	17.4	2.2+6.0+7.0	15.2	7.0+7.0	14.0		
2.2+2.2+2.8+2.8+7.0	17.0	2.2+2.8+2.8+2.8	10.6	2.2+7.0+7.0	16.2				
2.2+2.2+2.8+3.2+3.2	13.6	2.2+2.8+2.8+3.2	11.0	2.8+2.8+2.8	8.4				
2.2+2.2+2.8+3.2+4.0	14.4	2.2+2.8+2.8+4.0	11.8	2.8+2.8+3.2	8.8				
2.2+2.2+2.8+3.2+5.0	15.4	2.2+2.8+2.8+5.0	12.8	2.8+2.8+4.0	9.6				
2.2+2.2+2.8+3.2+6.0	16.4	2.2+2.8+2.8+6.0	13.8	2.8+2.8+5.0	10.6				
2.2+2.2+2.8+3.2+7.0	17.4	2.2+2.8+2.8+7.0	14.8	2.8+2.8+6.0	11.6				
2.2+2.2+2.8+4.0+4.0	15.2	2.2+2.8+3.2+3.2	11.4	2.8+2.8+7.0	12.6				
2.2+2.2+2.8+4.0+5.0	16.2	2.2+2.8+3.2+4.0	12.2	2.8+3.2+3.2	9.2				
2.2+2.2+2.8+4.0+6.0	17.2	2.2+2.8+3.2+5.0	13.2	2.8+3.2+4.0	10.0				
2.2+2.2+2.8+5.0+5.0	17.2	2.2+2.8+3.2+6.0	14.2	2.8+3.2+5.0	11.0				
2.2+2.2+3.2+3.2+3.2	14.0	2.2+2.8+3.2+7.0	15.2	2.8+3.2+6.0	12.0				
2.2+2.2+3.2+3.2+4.0	14.8	2.2+2.8+4.0+4.0	13.0	2.8+3.2+7.0	13.0				
2.2+2.2+3.2+3.2+5.0	15.8	2.2+2.8+4.0+5.0	14.0	2.8+4.0+4.0	10.8				
2.2+2.2+3.2+3.2+6.0	16.8	2.2+2.8+4.0+6.0	15.0	2.8+4.0+5.0	11.8				
2.2+2.2+3.2+4.0+4.0	15.6	2.2+2.8+4.0+7.0	16.0	2.8+4.0+6.0	12.8				
2.2+2.2+3.2+4.0+5.0	16.6	2.2+2.8+5.0+5.0	15.0	2.8+4.0+7.0	13.8				
2.2+2.2+4.0+4.0+4.0	16.4	2.2+2.8+5.0+6.0	16.0	2.8+5.0+5.0	12.8				
2.2+2.2+4.0+4.0+5.0	17.4	2.2+2.8+5.0+7.0	17.0	2.8+5.0+6.0	13.8				
2.2+2.8+2.8+2.8+2.8	13.4	2.2+2.8+6.0+6.0	17.0	2.8+5.0+7.0	14.8				
2.2+2.8+2.8+2.8+3.2	13.8	2.2+3.2+3.2+3.2	11.8	2.8+6.0+6.0	14.8				
2.2+2.8+2.8+2.8+4.0	14.6	2.2+3.2+3.2+4.0	12.6	2.8+6.0+7.0	15.8				
2.2+2.8+2.8+2.8+5.0	15.6	2.2+3.2+3.2+5.0	13.6	2.8+7.0+7.0	16.8				
2.2+2.8+2.8+2.8+6.0	16.6	2.2+3.2+3.2+6.0	14.6	3.2+3.2+3.2	9.6				
2.2+2.8+2.8+3.2+3.2	14.2	2.2+3.2+3.2+7.0	15.6	3.2+3.2+4.0	10.4				
2.2+2.8+2.8+3.2+4.0	15.0	2.2+3.2+4.0+4.0	13.4	3.2+3.2+5.0	11.4				
2.2+2.8+2.8+3.2+5.0	16.0	2.2+3.2+4.0+5.0	14.4	3.2+3.2+6.0	12.4				
2.2+2.8+2.8+3.2+6.0	17.0	2.2+3.2+4.0+6.0	15.4	3.2+3.2+7.0	13.4				
2.2+2.8+2.8+4.0+4.0	15.8	2.2+3.2+4.0+7.0	16.4	3.2+4.0+4.0	11.2				
2.2+2.8+2.8+4.0+5.0	16.8	2.2+3.2+5.0+5.0	15.4	3.2+4.0+5.0	12.2				
2.2+2.8+3.2+3.2+3.2	14.6	2.2+3.2+5.0+6.0	16.4	3.2+4.0+6.0	13.2				

5 Room		4 Room		3 Room		2 Room		1 Room	
Indoor Unit Capacity (kW)	Total Indoor Capacity (kW)	Indoor Unit Capacity (kW)	Total Indoor Capacity (kW)	Indoor Unit Capacity (kW)	Indoor Unit Capacity (kW)	Total Indoor Capacity (kW)	Indoor Unit Capacity (kW)	Total Indoor Capacity (kW)	Indoor Unit Capacity (kW)
2.2+2.8+3.2+3.2+4.0	15.4	2.2+3.2+5.0+7.0	17.4	3.2+4.0+7.0	14.2				
2.2+2.8+3.2+3.2+5.0	16.4	2.2+3.2+6.0+6.0	17.4	3.2+5.0+5.0	13.2				
2.2+2.8+3.2+3.2+6.0	17.4	2.2+4.0+4.0+4.0	14.2	3.2+5.0+6.0	14.2				
2.2+2.8+3.2+4.0+4.0	16.2	2.2+4.0+4.0+5.0	15.2	3.2+5.0+7.0	15.2				
2.2+2.8+3.2+4.0+5.0	17.2	2.2+4.0+4.0+6.0	16.2	3.2+6.0+6.0	15.2				
2.2+2.8+4.0+4.0+4.0	17.0	2.2+4.0+4.0+7.0	17.2	3.2+6.0+7.0	16.2				
2.2+3.2+3.2+3.2+3.2	15.0	2.2+4.0+5.0+5.0	16.2	3.2+7.0+7.0	17.2				
2.2+3.2+3.2+3.2+4.0	15.8	2.2+4.0+5.0+6.0	17.2	4.0+4.0+4.0	12.0				
2.2+3.2+3.2+3.2+5.0	16.8	2.2+5.0+5.0+5.0	17.2	4.0+4.0+5.0	13.0				
2.2+3.2+3.2+4.0+4.0	16.6	2.8+2.8+2.8+2.8	11.2	4.0+4.0+6.0	14.0				
2.2+3.2+4.0+4.0+4.0	17.4	2.8+2.8+2.8+3.2	11.6	4.0+4.0+7.0	15.0				
2.8+2.8+2.8+2.8+2.8	14.0	2.8+2.8+2.8+4.0	12.4	4.0+5.0+5.0	14.0				
2.8+2.8+2.8+2.8+3.2	14.4	2.8+2.8+2.8+5.0	13.4	4.0+5.0+6.0	15.0				
2.8+2.8+2.8+2.8+4.0	15.2	2.8+2.8+2.8+6.0	14.4	4.0+5.0+7.0	16.0				
2.8+2.8+2.8+2.8+5.0	16.2	2.8+2.8+2.8+7.0	15.4	4.0+6.0+6.0	16.0				
2.8+2.8+2.8+2.8+6.0	17.2	2.8+2.8+3.2+3.2	12.0	4.0+6.0+7.0	17.0				
2.8+2.8+2.8+3.2+3.2	14.8	2.8+2.8+3.2+4.0	12.8	5.0+5.0+5.0	15.0				
2.8+2.8+2.8+3.2+4.0	15.6	2.8+2.8+3.2+5.0	13.8	5.0+5.0+6.0	16.0				
2.8+2.8+2.8+3.2+5.0	16.6	2.8+2.8+3.2+6.0	14.8	5.0+5.0+7.0	17.0				
2.8+2.8+2.8+4.0+4.0	16.4	2.8+2.8+3.2+7.0	15.8	5.0+6.0+6.0	17.0				
2.8+2.8+2.8+4.0+5.0	17.4	2.8+2.8+4.0+4.0	13.6						
2.8+2.8+3.2+3.2+3.2	15.2	2.8+2.8+4.0+5.0	14.6						
2.8+2.8+3.2+3.2+4.0	16.0	2.8+2.8+4.0+6.0	15.6						
2.8+2.8+3.2+3.2+5.0	17.0	2.8+2.8+4.0+7.0	16.6						
2.8+2.8+3.2+4.0+4.0	16.8	2.8+2.8+5.0+5.0	15.6						
2.8+3.2+3.2+3.2+3.2	15.6	2.8+2.8+5.0+6.0	16.6						
2.8+3.2+3.2+3.2+4.0	16.4	2.8+3.2+3.2+3.2	12.4						
2.8+3.2+3.2+3.2+5.0	17.4	2.8+3.2+3.2+4.0	13.2						
2.8+3.2+3.2+4.0+4.0	17.2	2.8+3.2+3.2+5.0	14.2						
3.2+3.2+3.2+3.2+3.2	16.0	2.8+3.2+3.2+6.0	15.2						
3.2+3.2+3.2+3.2+4.0	16.8	2.8+3.2+3.2+7.0	16.2						
		2.8+3.2+4.0+4.0	14.0						
		2.8+3.2+4.0+5.0	15.0						
		2.8+3.2+4.0+6.0	16.0						
		2.8+3.2+4.0+7.0	17.0						
		2.8+3.2+5.0+5.0	16.0						
		2.8+3.2+5.0+6.0	17.0						
		2.8+4.0+4.0+4.0	14.8						
		2.8+4.0+4.0+5.0	15.8						
		2.8+4.0+4.0+6.0	16.8						
		2.8+4.0+5.0+5.0	16.8						
		3.2+3.2+3.2+3.2	12.8						
		3.2+3.2+3.2+4.0	13.6						
		3.2+3.2+3.2+5.0	14.6						
		3.2+3.2+3.2+6.0	15.6						
		3.2+3.2+3.2+7.0	16.6						
		3.2+3.2+4.0+4.0	14.4						
		3.2+3.2+4.0+5.0	15.4						
		3.2+3.2+4.0+6.0	16.4						
		3.2+3.2+4.0+7.0	17.4						
		3.2+3.2+5.0+5.0	16.4						
		3.2+3.2+5.0+6.0	17.4						
		3.2+4.0+4.0+4.0	15.2						
		3.2+4.0+4.0+5.0	16.2						
		3.2+4.0+4.0+6.0	17.2						
		3.2+4.0+5.0+5.0	17.2						
		4.0+4.0+4.0+4.0	16.0						
		4.0+4.0+4.0+5.0	17.0						

3. Dimensions

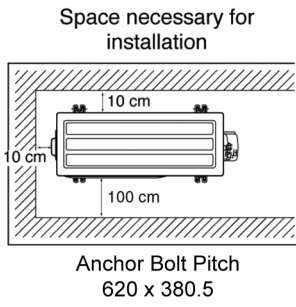

<Top View>

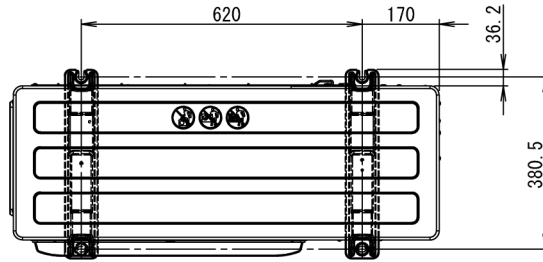

<Side View>

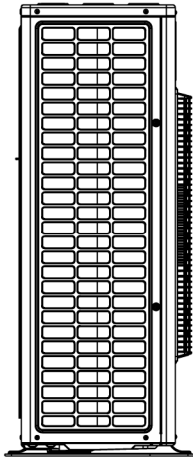

<Front View>

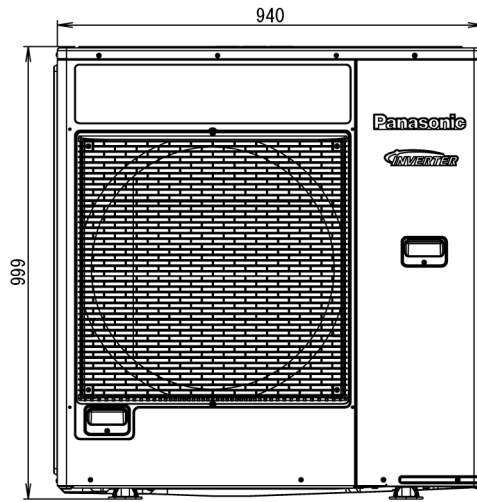

<Side View>

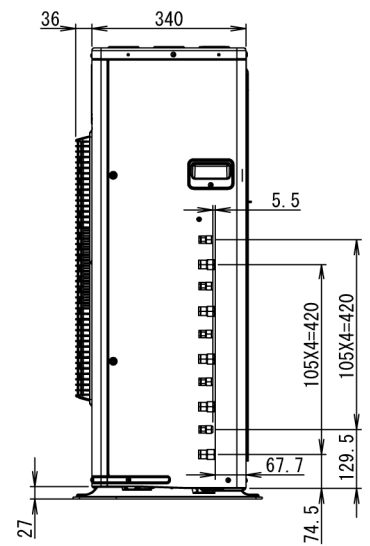

Unit: mm

4. Refrigeration Cycle Diagram

4.1 CU-4E27PBD

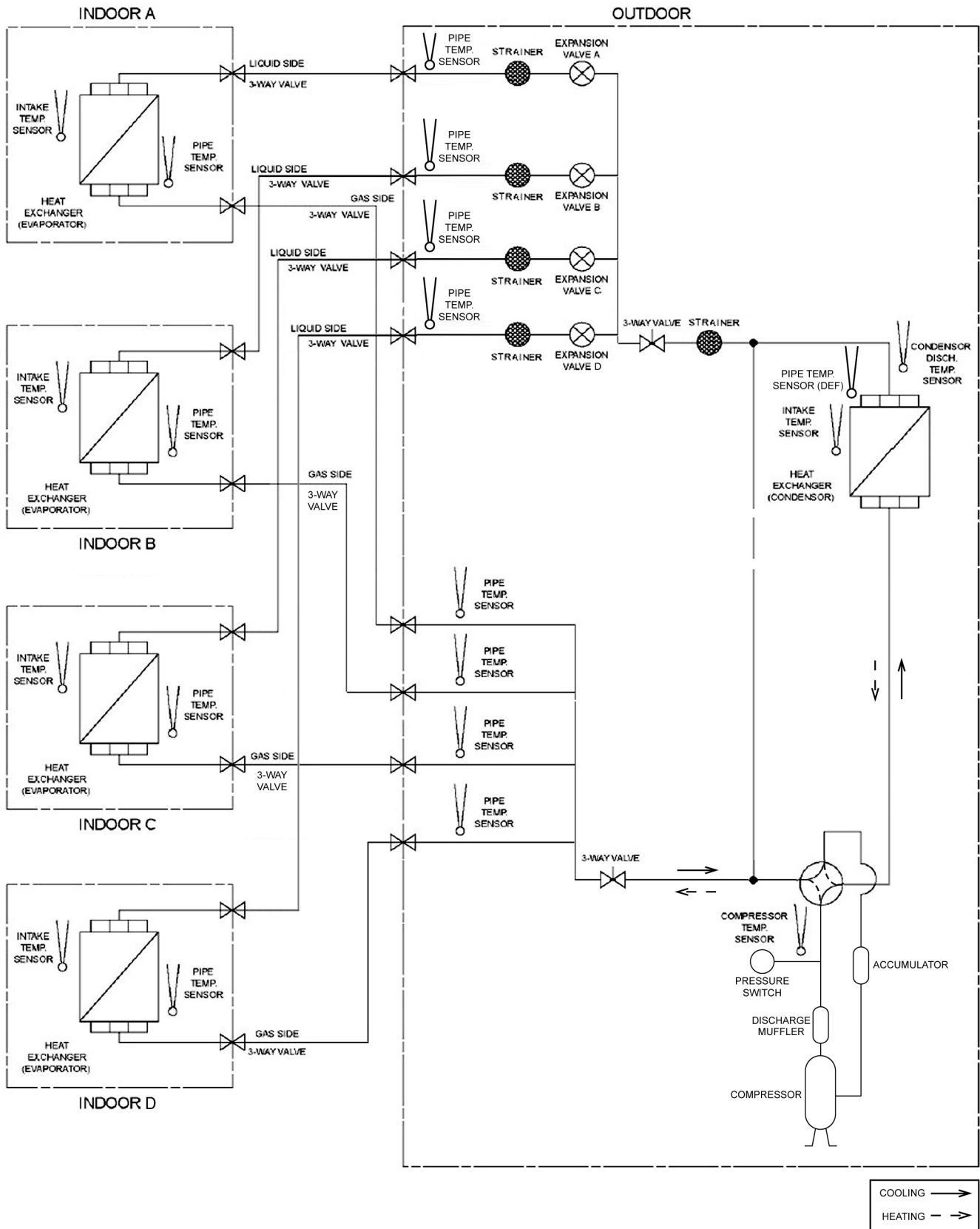

4.2 CU-5E34PBD

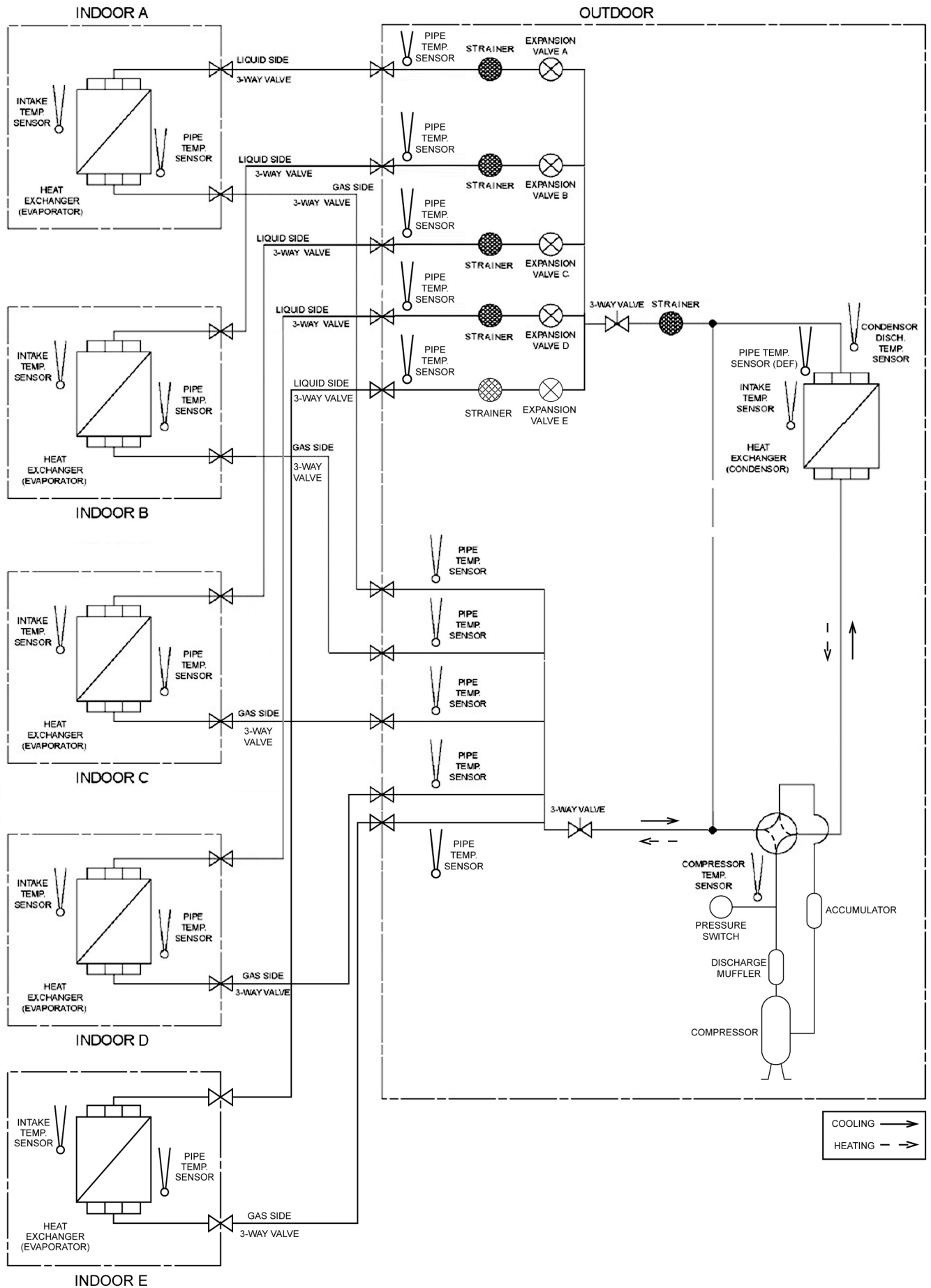

5. Block Diagram

5.1 CU-4E27PBD

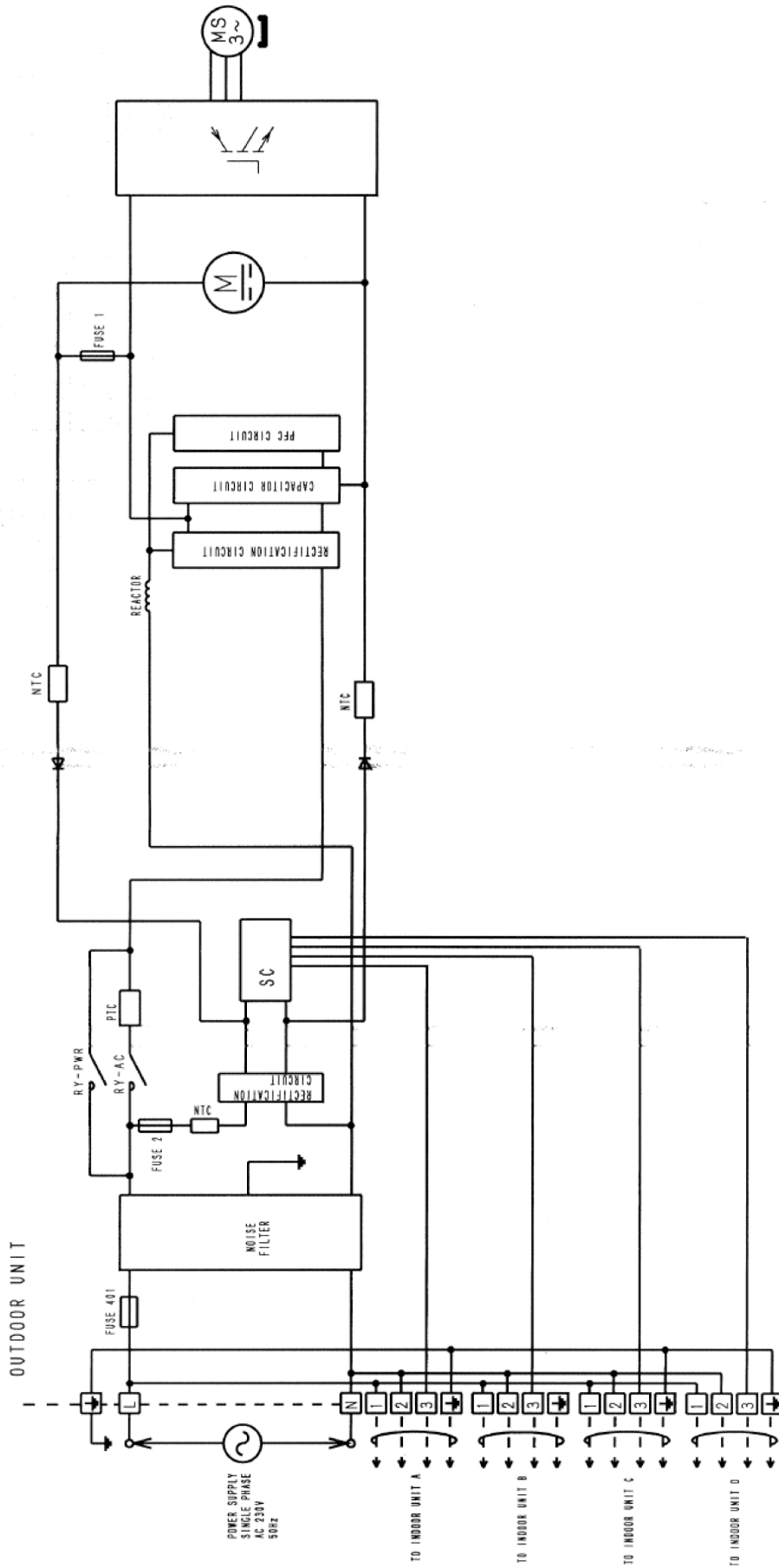

5.2 CU-5E34PBD

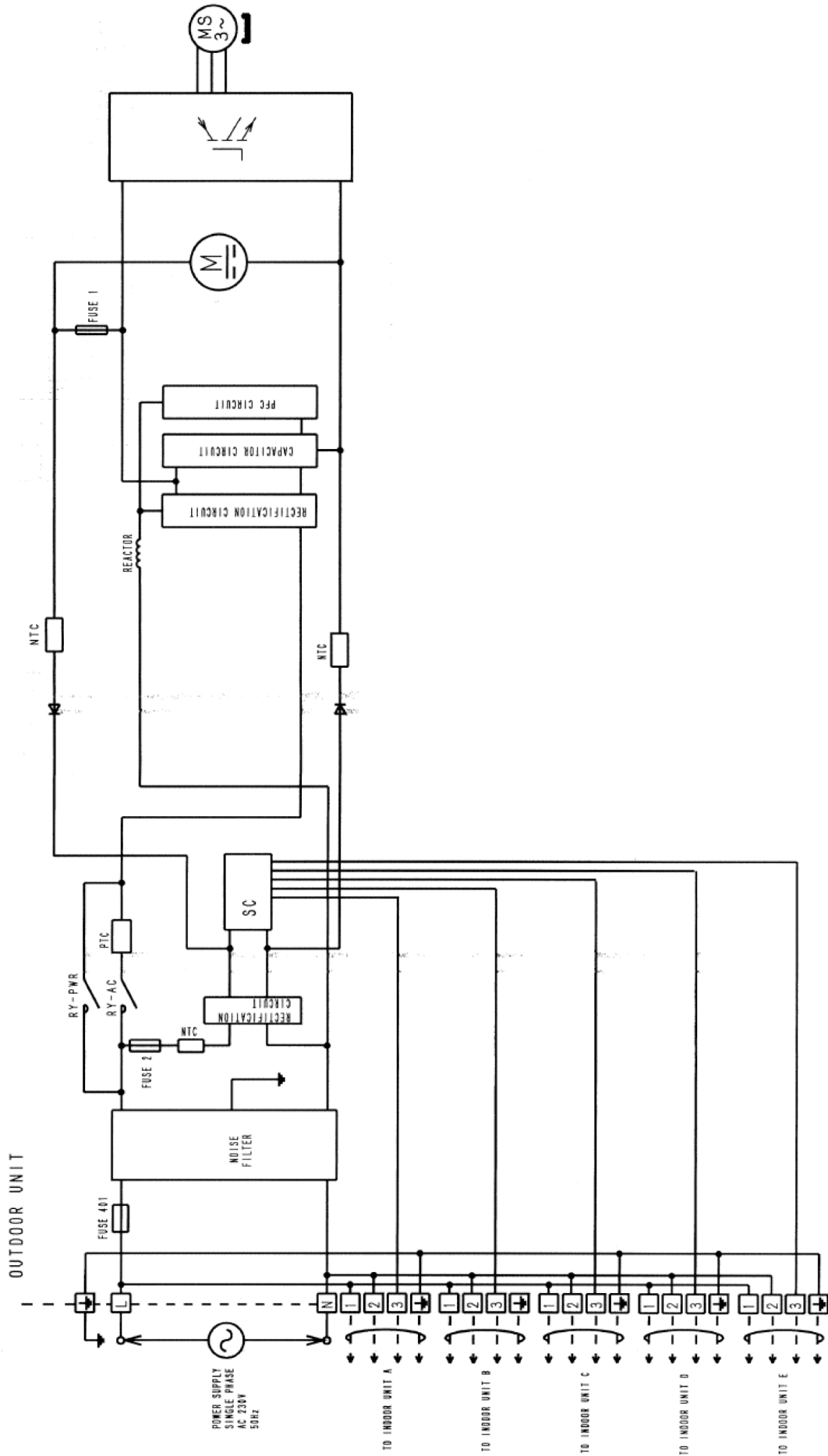

6. Wiring Connection Diagram

6.1 CU-4E27PBD

Resistance of Compressor Windings

CONNECTION	5KD240XAL21 (Ω)
U - V	0.72
U - W	0.73
V - W	0.71

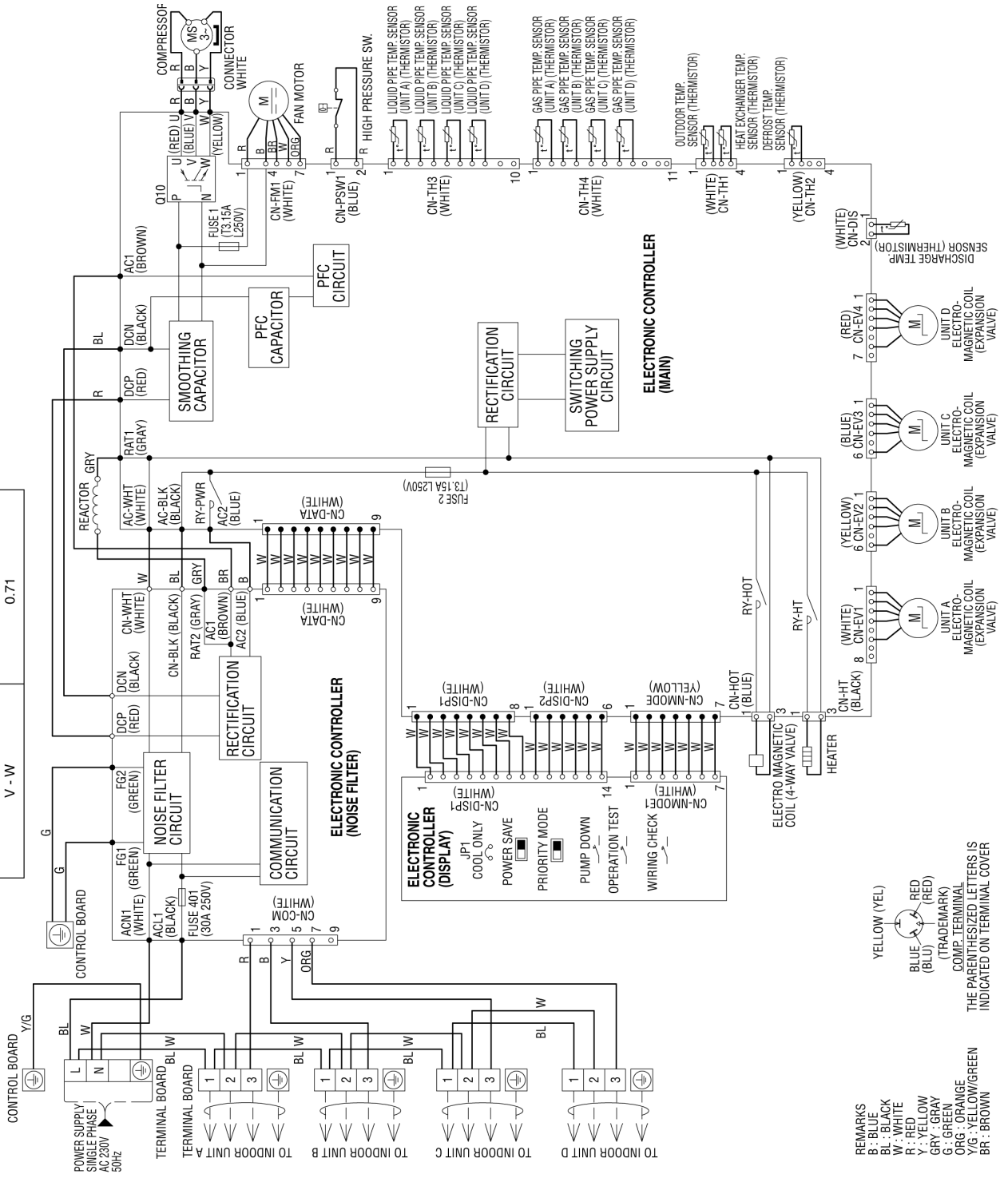

6.2 CU-5E34PBD

Resistance of Compressor Windings

CONNECTION	5KD240XAL21 (Ω)
U - V	0.72
U - W	0.73
V - W	0.71

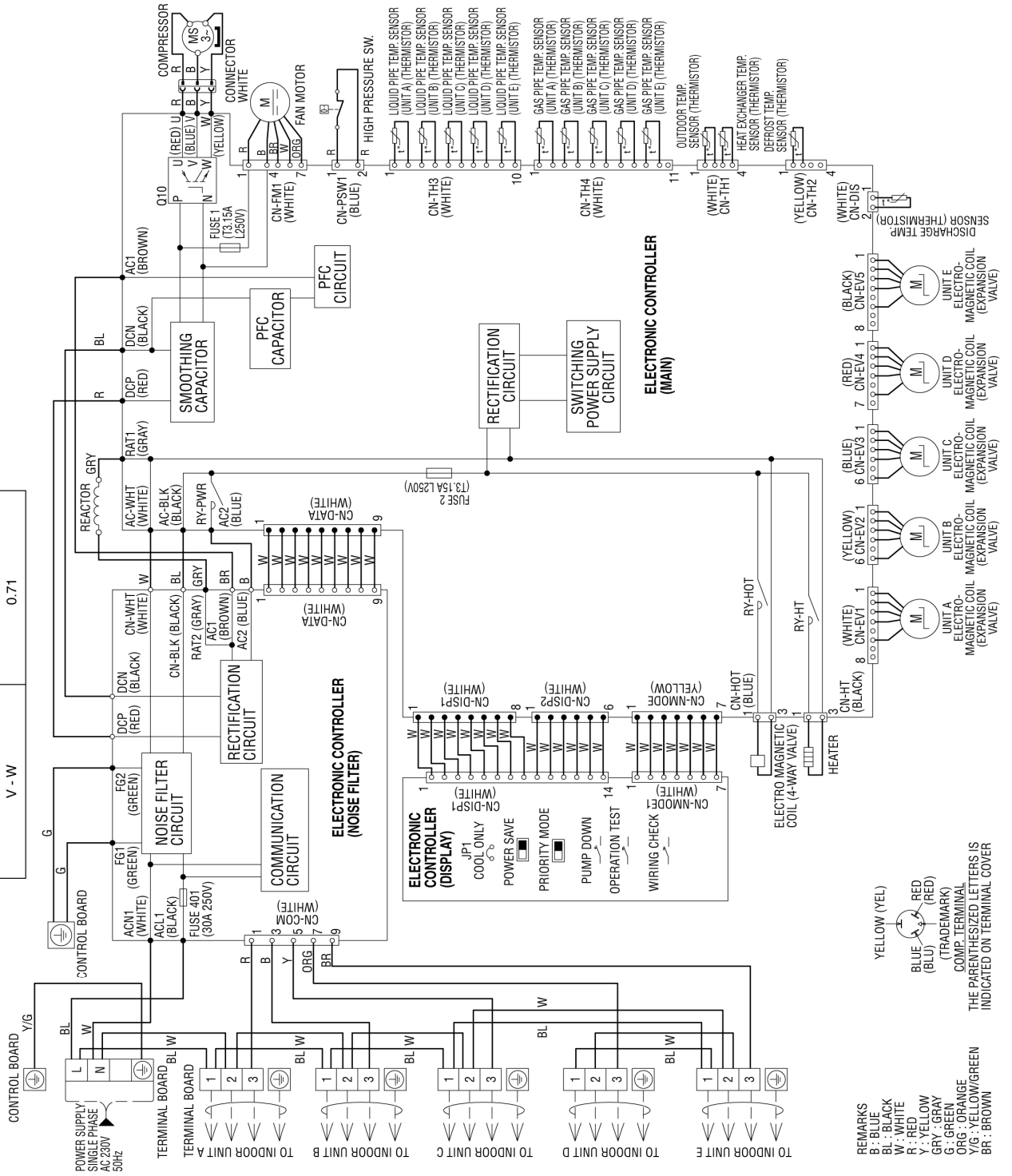

- REMARKS
 B : BLUE
 BL : BLACK
 W : WHITE
 R : RED
 Y : YELLOW
 GRY : GRAY
 G : GREEN
 YG : YELLOW/GREEN
 BR : BROWN
- YELLOW (YEL)
 BLUE (BLU)
 (TRADEMARK)
 COMP. TERMINAL
 THE PARENTHEZIZED LETTERS IS INDICATED ON TERMINAL COVER

7. Electronic Circuit Diagram

7.1 CU-4E27PBD

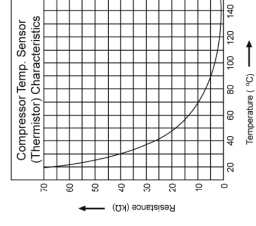
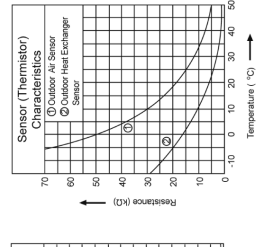
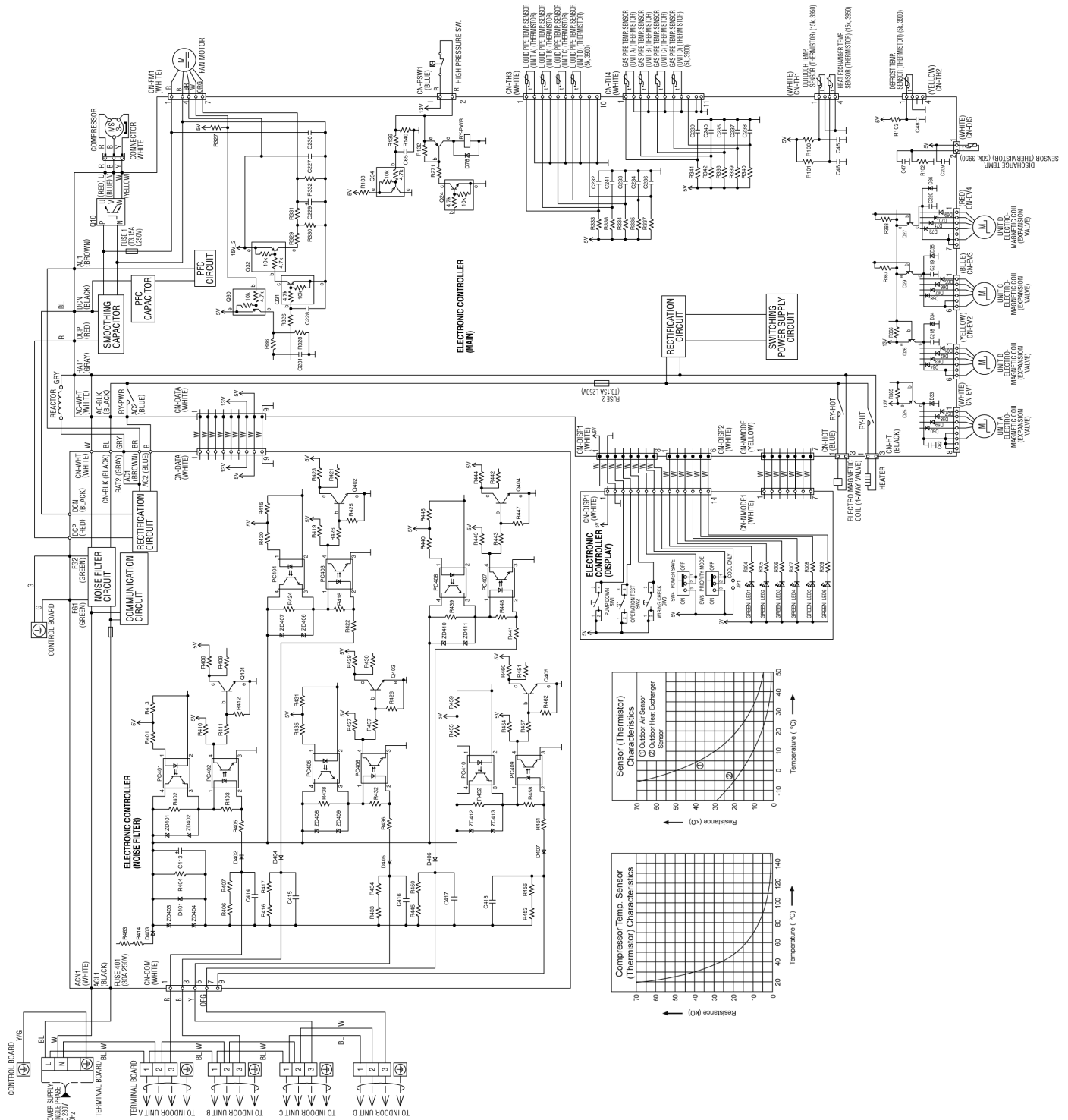

7.2 CU-5E34PBD

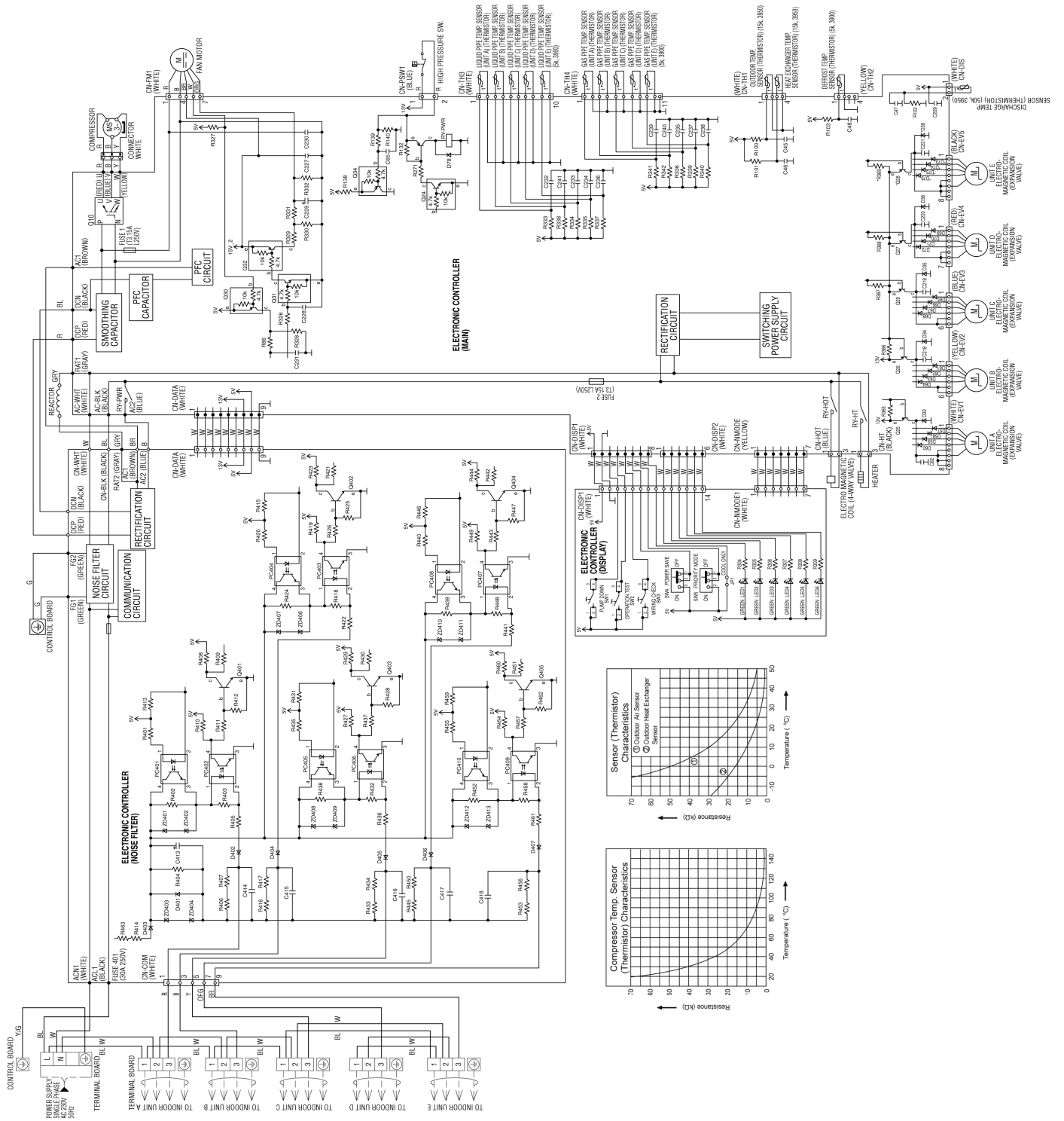

8. Printed Circuit Board

8.1 Main Printed Circuit Board

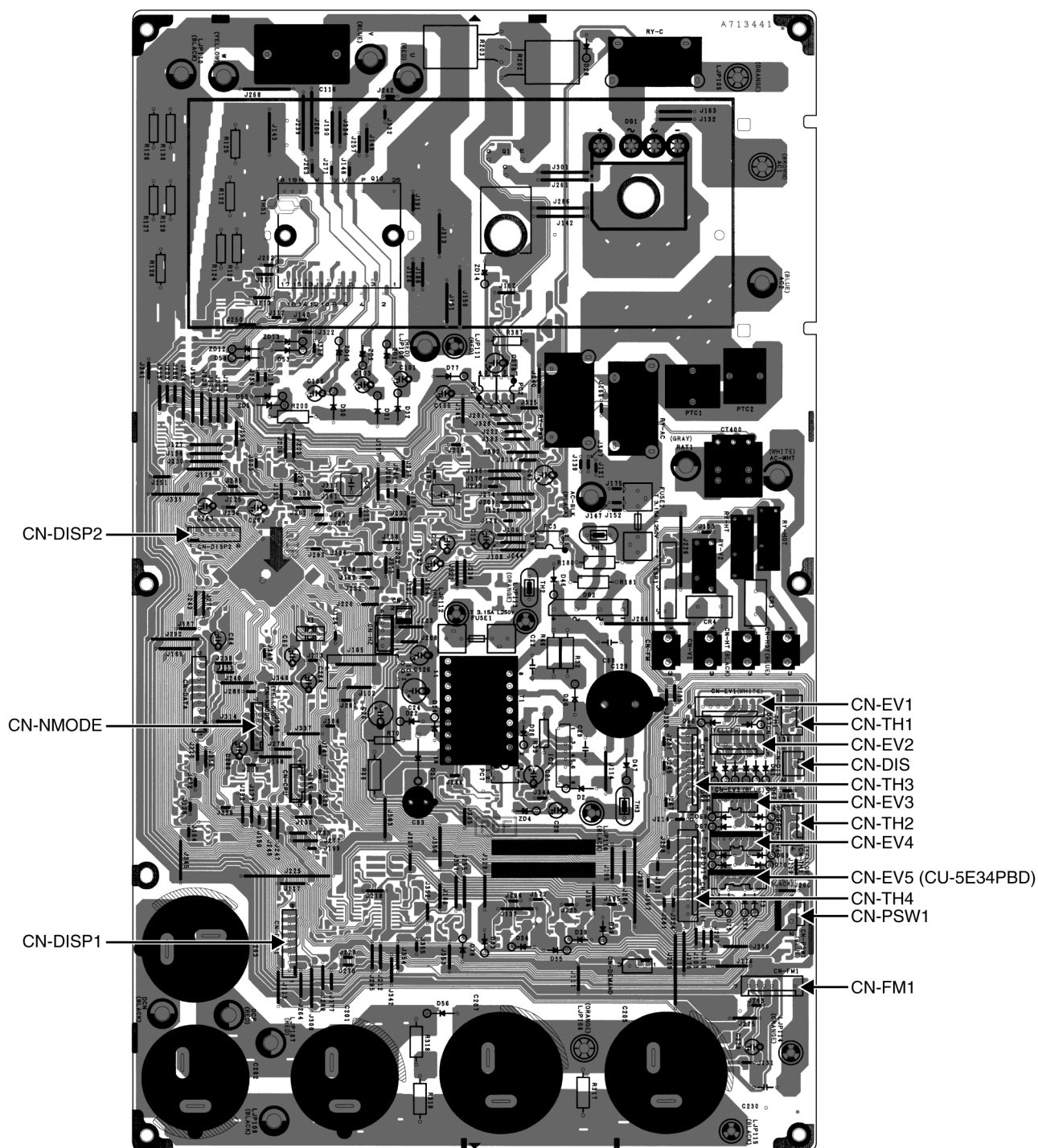

8.2 Noise Filter Printed Circuit Board

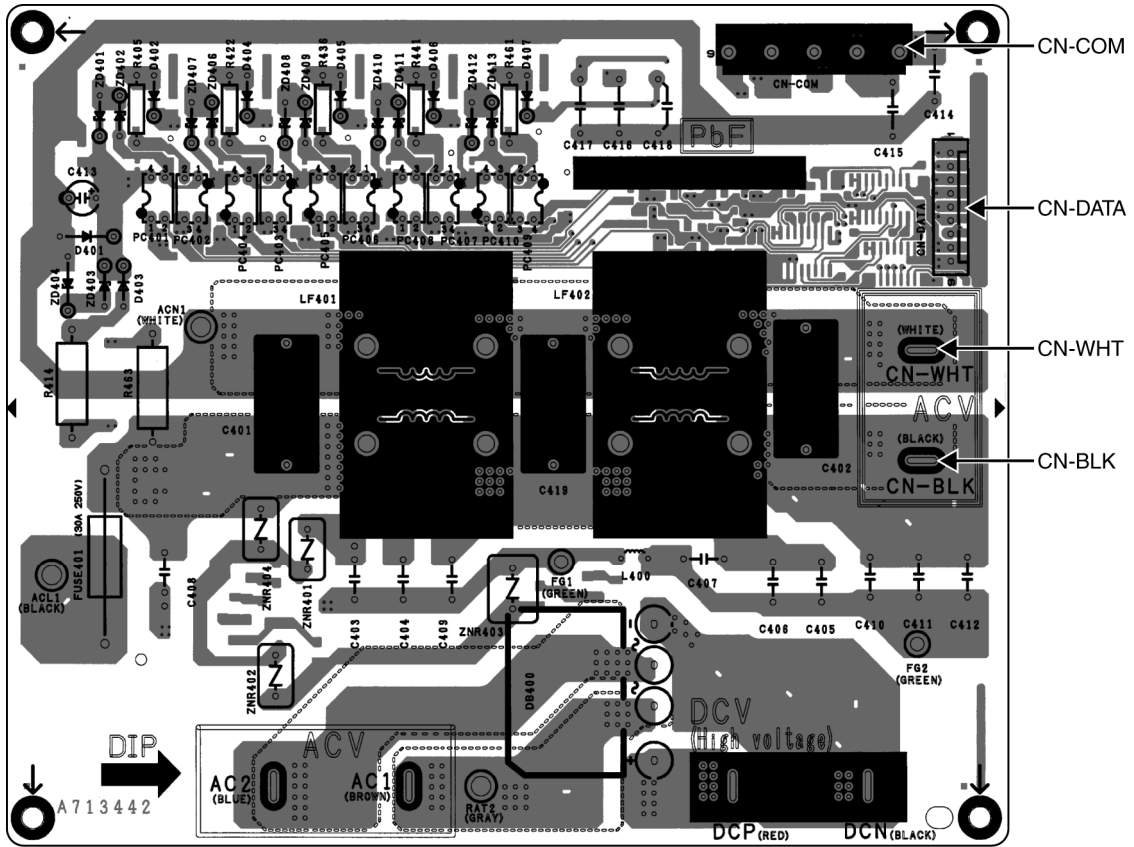

8.3 Display Printed Circuit Board

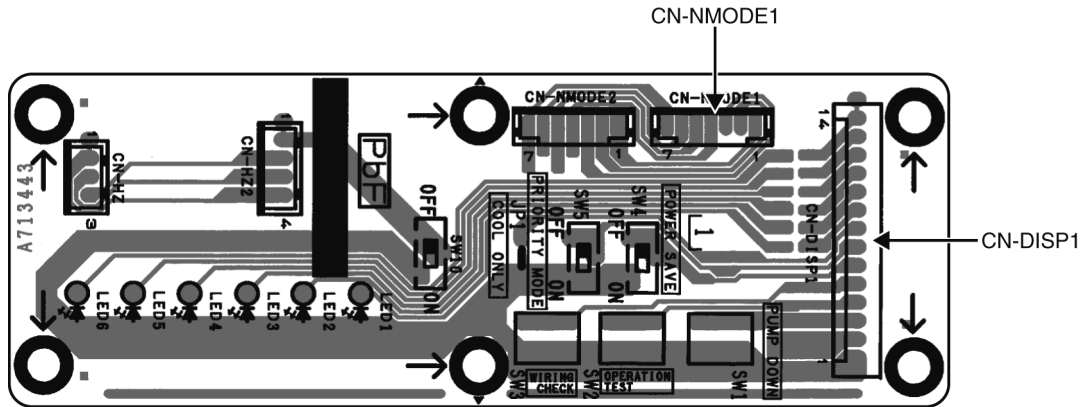

9. Installation Information

9.1 CU-4E27PBD

9.1.1 Check Points

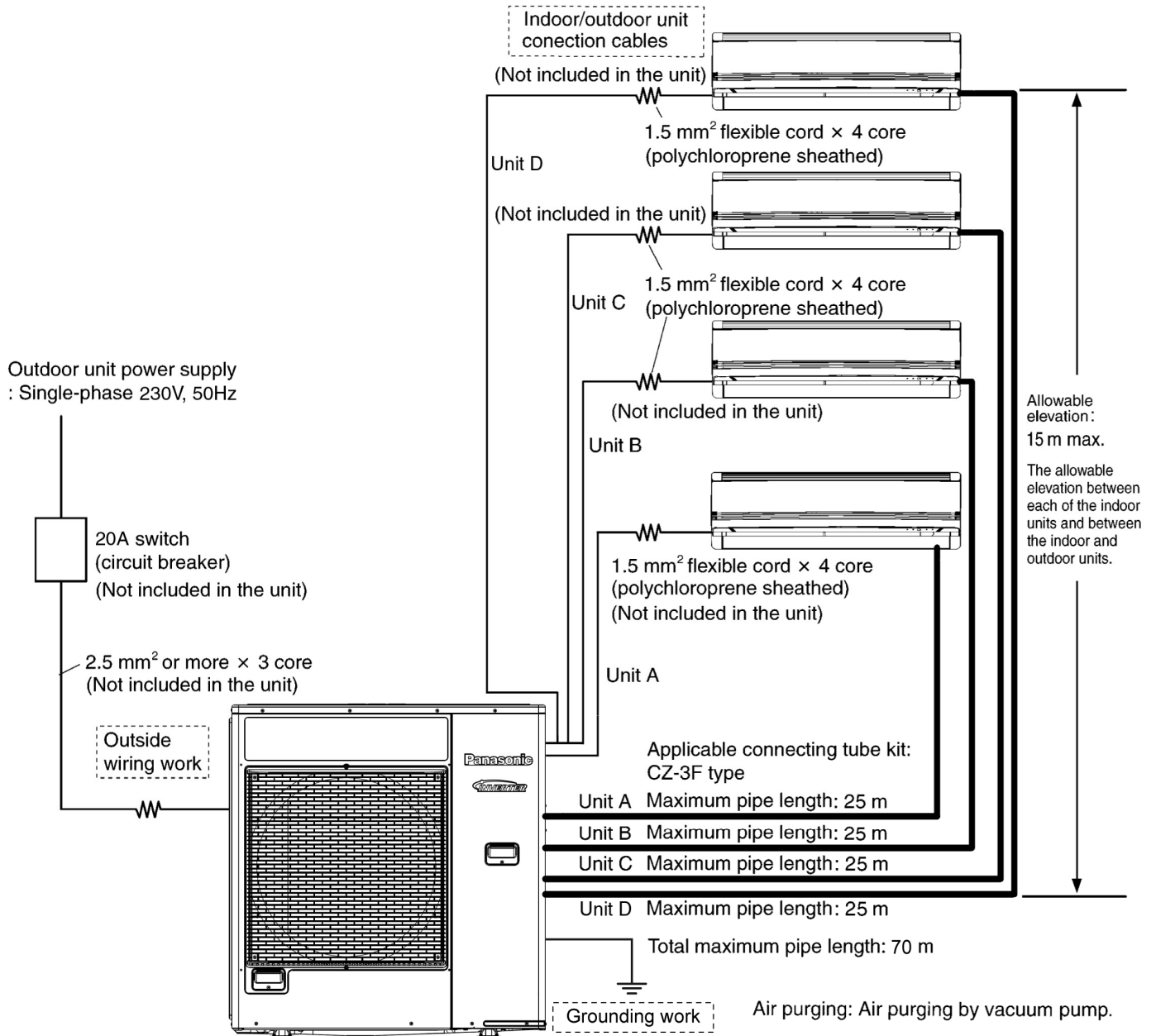

9.2 CU-5E34PBD

9.2.1 Check Points

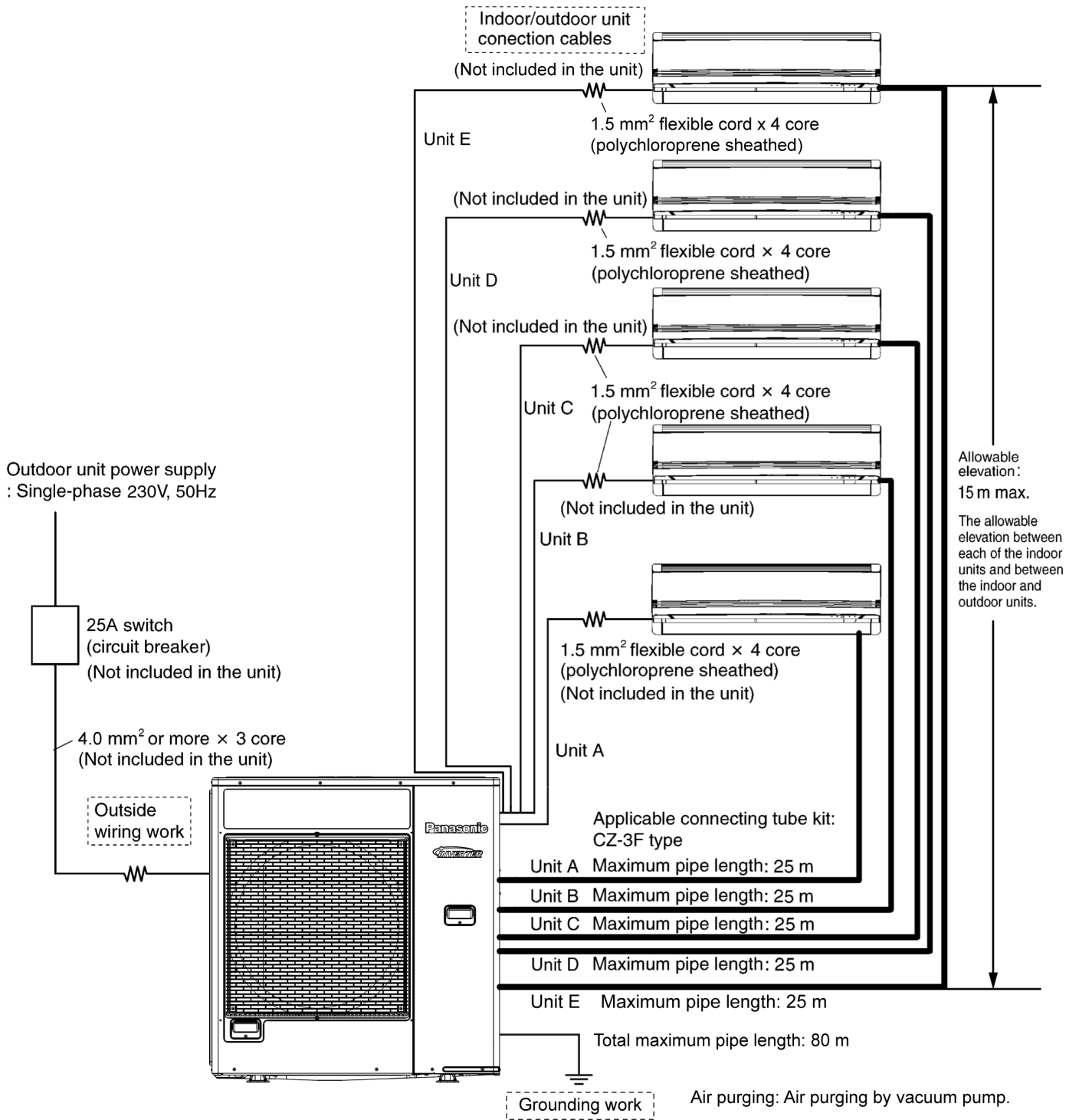

10. Installation Instruction

10.1 Select The Best Location

- If an awning is built over the unit to prevent direct sunlight or rain, be careful that heat radiation from the condenser is not obstructed.
- There should not be any animal or plant which could be affected by hot air discharged.
- Keep the spaces indicated by arrows from wall, ceiling, fence or other obstacles.
- Do not place any obstacles which may cause a short circuit of the discharged air.

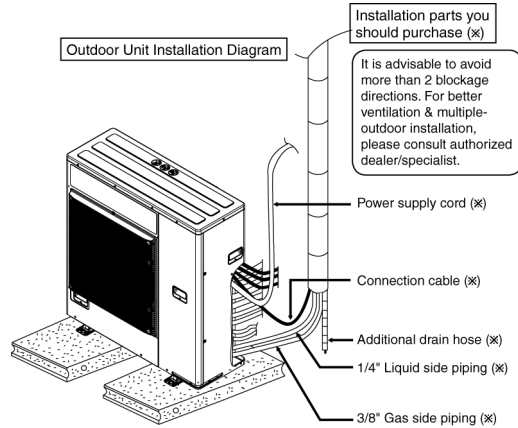

• This illustration is for explanation purposes only.
 * Note:
 Respective indoor unit installation procedure shall refer to instruction manual provided in the indoor unit packaging.

Refrigerant piping size		
Outdoor Unit	CU-4E27***	CU-5E34***
Liquid - side	ø 6.35 t0.8	ø 6.35 t0.8
Gas - side	ø 9.52 t0.8 *(ø 12.7 t0.8)	ø 9.52 t0.8 *(ø 12.7 t0.8)

*In case of indoor is CS-E21***, CS-XE21***, CS-ME21***, CS-E24***, then ø 12.7 t0.8 gas-pipe size must be used together with CZ-MA2P (pipe size expander)

Outdoor Unit	CU-4E27***	CU-5E34***
Equivalent length	45 m	45 m

- If total piping length of all indoor units exceed the equivalent length listed above, additional charge with 20g of refrigerant (R410A) for each additional meter of piping.

Allowable piping length				
Outdoor Unit			CU-4E27***	CU-5E34***
Allowable piping length of each indoor unit (min. ~ max.)			3 m ~ 25 m	3 m ~ 25 m
Allowable total piping length of all indoor unit			70 m or less	80 m or less
Height difference between indoor and outdoor unit	Outdoor unit located on upper side	(a)	15 m or less	15 m or less
	Outdoor unit located otherwise	(b)	7.5 m or less	7.5 m or less
Height difference between indoor unit	Outdoor unit located on upper side	(c)	7.5 m or less	7.5 m or less
	Outdoor unit located otherwise	(d)	15 m or less	15 m or less

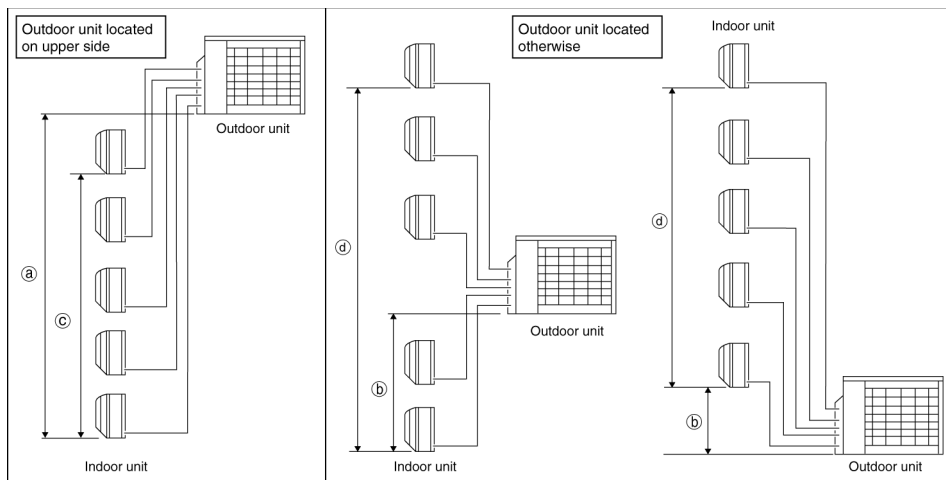

Outdoor Unit Installation Guidelines

- Where a wall or other obstacle is in the path of outdoor unit's intake or exhaust airflow, follow the installation guidelines below.
- For any of the below installation patterns, the wall height on the exhaust side should be 1200mm or less.

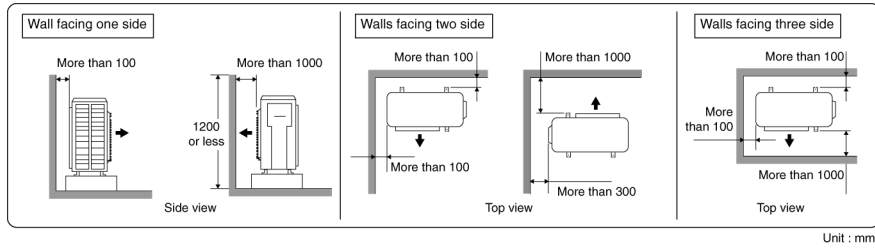

10.2 Install The Outdoor Unit

- After selecting the best location, start installation to Indoor/Outdoor Unit Installation Diagram.
 1. Fix the unit on concrete or rigid frame firmly and horizontally by bolt nut (ø10 mm).
 2. When installing at roof, please consider strong wind and earthquake. Please fasten the installation stand firmly with bolt or nails.

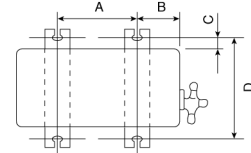

Model	A	B	C	D
CU-4E27***, CU-5E34***	620 mm	170 mm	20 mm	380.5 mm

10.3 Connect The Piping

- Remove the cabinet side plate (metal) from the unit by loosening six screws.

Connecting The Piping To Outdoor Unit

Decide piping length and then cut by using pipe cutter.

Remove burrs from cut edge. Make flare after inserting the flare nut (locate at valve) onto the copper pipe.

Align center of piping to valves and then tighten with torque wrench to the specified torque as stated in the table.

Do not over tighten, over tightening may cause gas leakage	
Piping size	Torque
1/4" [6.35 mm]	[18N•m (1.8 kgf.m)]
3/8" [9.52 mm]	[42 N•m (4.3 kgf.m)]
1/2" [12.7 mm]	[55 N•m (5.6 kgf.m)]
5/8" [15.88 mm]	[65 N•m (6.6 kgf.m)]
3/4" [19.05 mm]	[100N•m (10.2 kgf.m)]

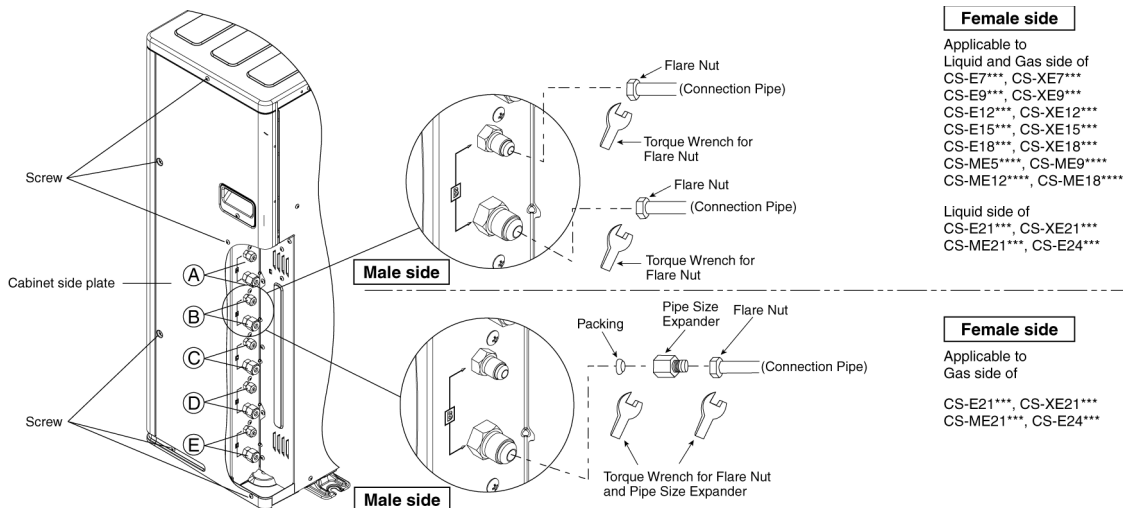

CUTTING AND FLARING THE PIPING

1. Please cut using pipe cutter and then remove the burrs.
2. Remove the burrs by using reamer. If burrs is not removed, gas leakage may be caused. Turn the piping end down to avoid the metal powder entering the pipe.
3. Please make flare after inserting the flare nut onto the copper pipes.

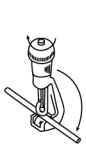

1. To cut

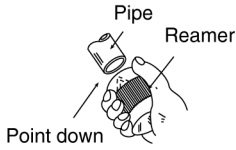

2. To remove burrs

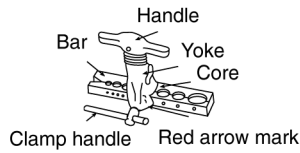

3. To flare

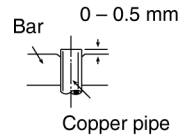

■ Improper flaring ■

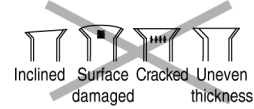

When properly flared, the internal surface of the flare will evenly shine and be of even thickness. Since the flare part comes into contact with the connections, carefully check the flare finish.

10.4 Evacuation Of The Equipment

WHEN INSTALLING AN AIR CONDITIONER, BE SURE TO EVACUATE THE AIR INSIDE THE INDOOR UNIT AND PIPES in the following procedure.

1. Connect a charging hose with a push pin to the Low side of a charging set and the service port of the gas side 3-way valve.
 - Be sure to connect the end of the charging hose with the push pin to the service port.
2. Connect the center hose of the charging set to a vacuum pump.
3. Turn on the power switch of the vacuum pump and make sure that the needle in the gauge moves from 0 cmHg (0MPa) to -76 cmHg (-0.1 MPa). Then evacuate the air approximately ten minutes.
4. Close the Low side valve of the charging set and turn off the vacuum pump. Make sure that the needle in the gauge does not move after approximately five minutes.

Note : BE SURE TO TAKE THIS PROCEDURE IN ORDER TO AVOID REFRIGERANT GAS LEAKAGE.

5. Disconnect the charging hose from the vacuum pump and from the service port of the 3-way valve.
6. Tighten the service port caps of gas side 3-way valve at a torque of 18 N•m with a torque wrench.
7. Remove the valve caps of both of the gas side and liquid side 3-way valve. Position both of the valves to "OPEN" using a hexagonal wrench (4 mm).
8. Mount valve caps onto the gas side and liquid side of the 3-way valve.
 - Be sure to check for gas leakage.

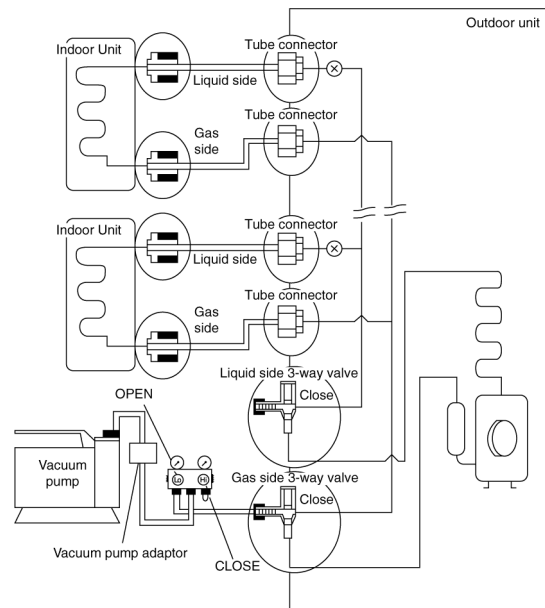

⚠ CAUTION

- If gauge needle does not move from 0 cmHg (0 MPa) to -76 cmHg (-0.1 MPa), in step ③ above take the following measure:
- If the leak stops when the piping connections are tightened further, continue working from step ③.
- If the leak does not stop when the connections are retightened, repair location of leak.
- Do not release refrigerant during piping work for installation and reinstallation.
- Take care of the liquid refrigerant, it may cause frostbite.

10.5 Connect The Cable To The Outdoor Unit

- Remove the particular plate from the unit by loosening two screws.
- Cable connection to the power supply through isolating Devices (Disconnecting means).
 - Connect approved type polychloroprene sheathed **power supply cord** CU-4E27*** (3 x 2.5 mm²), CU-5E34*** (3 x 4.0 mm²) 245 IEC 57 type designation or heavier cord to the terminal board, and connect the others end of the cord to Isolating Devices (Disconnecting means).
- Connection cable** between indoor unit and outdoor unit shall be approved polychloroprene sheathed 4 x 1.5 mm² flexible cord, type designation 245 IEC 57 or heavier cord. Allowable connection cable length of each indoor unit shall be 30 m or less.
- Connect the power supply cord and connection cable between indoor unit and outdoor unit according to the diagram as shown.

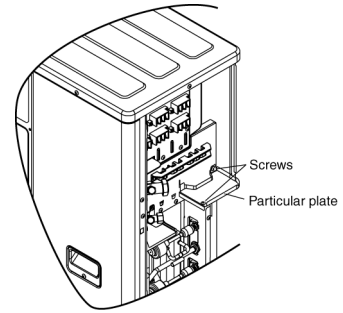

CU-4E27***

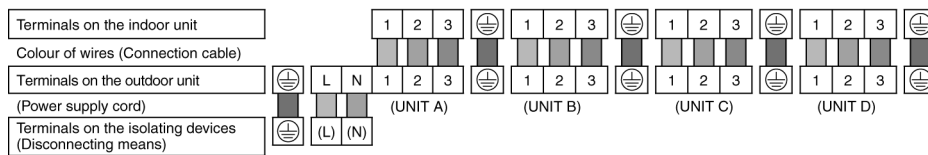

CU-5E34***

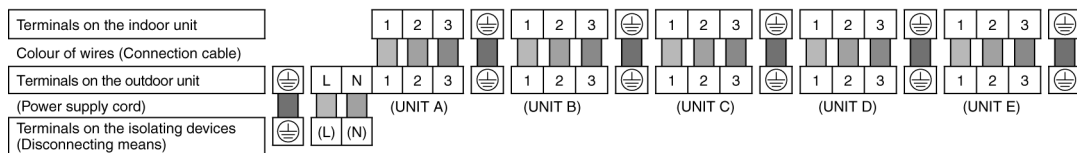

Remarks:



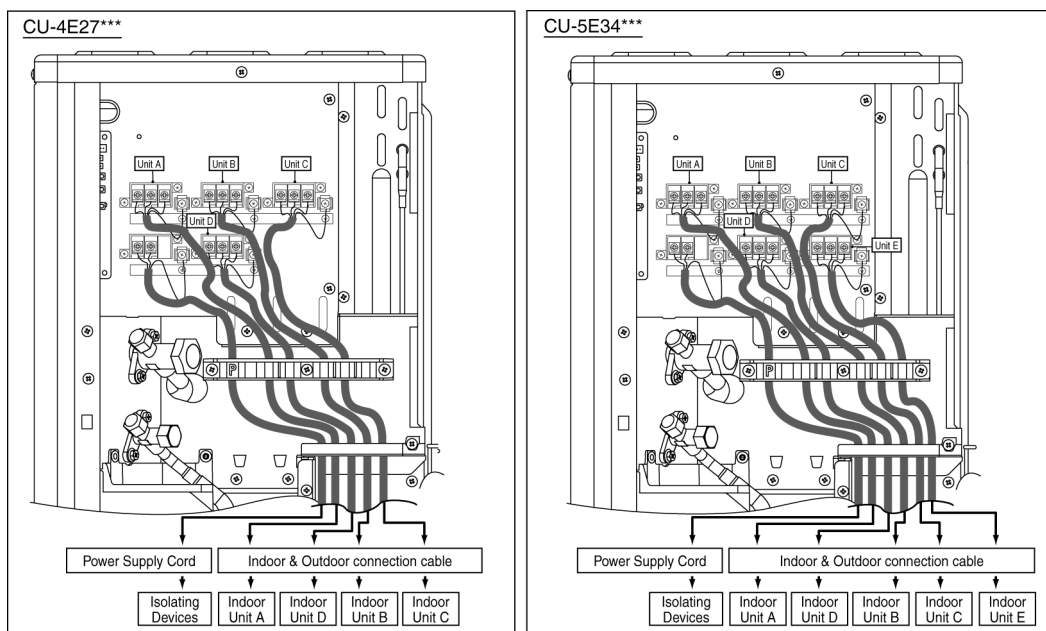

It is the responsibility of the installer or user of the equipment to ensure, by consultation with the suitable distribution/supply network operator if necessary, that the equipment should be connected only to a supply with,

- Short-circuit power $S_{sc} \geq 1150\text{kW}$
- Service current capacity $\geq 100\text{A}$ per phase

The equipment complies with IEC/EN 61000-3-11 and IEC/EN 61000-3-12. Please liaise with supply authority to ensure that the above items at the interface point are sufficient for the installation of the equipment.

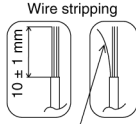
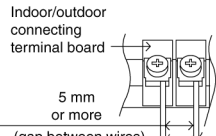

5. For wire stripping and connection requirement, refer to the diagram below.
6. Secure the power supply cord and connecting cables onto the control board with the holder.
7. Attach the control board cover back to the original position with screw.

WIRE STRIPPING AND CONNECTING REQUIREMENT			
<p>Wire stripping</p>  <p>No loose strand when inserted</p>	<p>Indoor/outdoor connecting terminal board</p>  <p>5 mm or more (gap between wires)</p>	<p>Conductor fully inserted</p>  <p>ACCEPT</p>	<p>Conductor over inserted</p>  <p>PROHIBITED</p>
		<p>Conductor not fully inserted</p>  <p>PROHIBITED</p>	<p style="text-align: center;">⚠ WARNING</p> <p>⚡ This equipment must be properly earthed.</p> <ul style="list-style-type: none"> • Note: Isolating Devices (Disconnecting means) should have minimum 3.0 mm contact gap. • Earth wire shall be Yellow/Green (Y/G) in colour and longer than other AC wires for safety reason.

10.6 Heat Insulation

⚠ CAUTION	Use a material with good heat-resistant properties as the heat insulation for the pipes. Be sure to insulate both the gas-side and liquid-side pipes. If the pipes are not adequately insulated, condensation or water leakages may occur.
------------------	--

Liquid-side pipes	Material shall withstand 120°C or higher
Gas-side pipes	

10.7 Disposal Of Outdoor Unit Drain Water

- If a drain elbow is used, the unit should be placed on a stand which is taller than 5 cm.
- If the unit is used in an area where temperature falls below 0°C for 2 or 3 days in succession, it is recommended not to use a drain elbow, for the drain water freezes and the fan will not rotate.

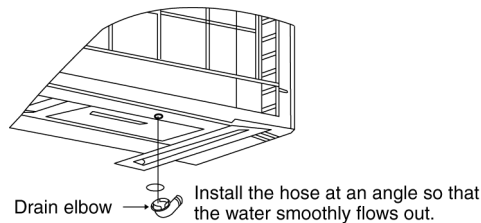

11. Operation Control

11.1 Cooling Operation

11.1.1 Outdoor fan control

- When cooling operation is enabled, based on outdoor ambient temperature, fan motor control will be adjusted according to figure below:

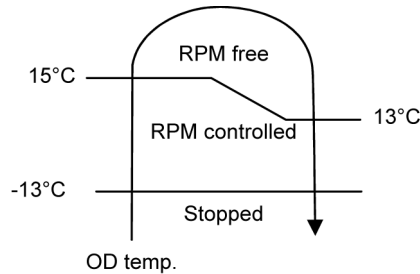

11.1.2 Annual Cooling control

- This control is to enable cooling operation when outdoor ambient temperature is low.
- Control start conditions:
 - Cooling operation is activated with compressor ON.
 - Outdoor ambient temperature is less than 15°C.
- Control contents:
 - When the above conditions are fulfilled, based on outdoor pipe temperature, the outdoor fan motor will operate according to figure below:

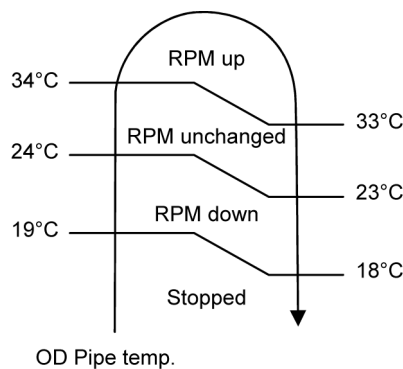

- To improve the judgment accuracy during annual cooling control, outdoor ambient temperature sampling for 2 minutes will be activated every 35 minutes under designated fan speed.
- Control stop conditions:
 - When either one of the start conditions are not complied.

11.1.3 Cooling Powerful Operation 1

- During cooling operation, this control is to concentrate outdoor unit capability to the powerful operation enabled indoor unit by temporary stop the capability supply to low load demand indoor units.
- Operation start condition:
 - Powerful operation ON for targeted indoor unit
- Operation content:
 - If other indoor units (where Powerful operation are OFF) achieve setting temperature continuously for 1 minute after received powerful command from indoor unit, then capability supply to other indoor units are stopped for minimum 3 minutes.
Capability supply stop period follows powerful operation period.
- Operation stops when comply either one of the following conditions:
 - When other indoor units (where Powerful operation are OFF) is demand for capacity.
 - When the powerful operation is OFF for all indoor units.
 - When Quiet operation received from 1 indoor unit.
 - When protection control starts.

11.2 Heating Operation

11.2.1 Outdoor fan control

- When heating operation is enabled, based on outdoor ambient temperature, fan motor control will be adjusted according to figure below for Heating overload control:

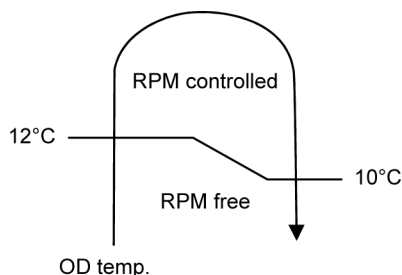

11.2.2 Heating Room Temp Sampling Control

- To improve the judgment accuracy, indoor room temperature sampling starts when any indoor unit has stopped capability supplied (heating thermo-off) during heating operation with compressor ON, outdoor unit will send signal to all thermo-off indoor units to ON fan motor and get room temperature sample.
- To prevent discharge temperature drop at indoor units which is ON when sampling the room temperature of heating thermo-off units, the compressor frequency is increased accordingly.
- However, if indoor room temperature is much higher compare to remote control setting temperature, before thermo-off, sampling of corresponding indoor unit will be cancelled.

11.2.3 Powerful Operation 2

- During cooling / heating operation, this control is to provide fast cooling / heating operation compare to normal operation.
- Operation start if all condition below are complied:
 - Powerful operation ON for indoor unit.
 - Not under Annual Cooling control.
- Operation content:
 - Outdoor fan speed will adjust automatically.
 - Compressor frequency will adjust automatically.
- Operation stop when comply either one of the follow conditions:
 - When the powerful operation is OFF for all indoor units.
 - When annual cooling control activated.

12. Simultaneous Operation Control

- Operation modes which can be selected using the remote control unit:
 - Automatic, Cooling, Dry, Heating and e-ion operation mode.
- Types of operation modes which can be performed simultaneously
 - Cooling operation and Cooling, Dry or e-ion operation.
 - Heating operation and Heating operation.
- Types of operation modes which cannot be performed simultaneously
 - During cooling operation, heating operation is impossible at another indoor unit in another room.
 - The priority is given to cooling operation if the cooling mode is selected first. In another room where heating mode is selected afterward, the POWER LED blinks to indicate the heating operation is in standby condition, where the fan is stopped hence no discharged air.
 - During heating operation, cooling operation is impossible at another indoor unit in another room.
 - The priority is given to heating operation if the heating mode is selected first. In another room where cooling mode is selected afterward, the POWER LED blinks to indicate the cooling operation is in standby condition, where the fan is stopped hence no discharged air.
- Operation mode priority control
 - The operation mode designated first by the indoor unit has priority.
 - If the priority indoor unit stops operation or initiates the fan operation, the priority is transferred to other indoor units.

“Waiting” denotes the standby status in which the POWER LED blinks (ON for 2.5 seconds and OFF for 0.5 seconds) and the fan is stopped.

ROOM B \ ROOM A		Non Priority Unit (2 nd ON)			
		Cooling	Dry	Heating	e-ion
Priority Unit (1 st ON)	Cooling	C	D	Waiting	E
	Dry	C	C	C	C
		C	D	Waiting	E
	Heating	D	D	D	D
		Waiting	Waiting	H	Stop
e-ion	H	H	H	H	
C	D	H	E		
E	E	Stop	E		

In the e-ion mode, priority is transferred to a non-priority unit.

Note

- C: Cooling operation mode
- D: Dry operation mode
- H: Heating operation mode
- E: e-ion operation mode

13. Protection Control

13.1 Freeze Prevention Control (Cool)

- When received freeze prevention signal from indoor unit, the compressor frequency changes according to indoor heat exchanger temperature.
- When indoor unit request capability OFF due to freeze condition, immediately the capability supply to targeted indoor unit stops.

13.2 Dew Prevention Control (Cool)

- When received dew prevention signal from indoor unit, which according to indoor intake temperature and indoor heat exchanger temperature the compressor frequency changes.

13.3 Electronic Parts Temperature Rise Protection 1 (Cool)

- This control prevents electronic parts temperature rise during cooling overload condition.
- Start conditions:
 - Outdoor ambient temperature is at protection region as shown in figure below:

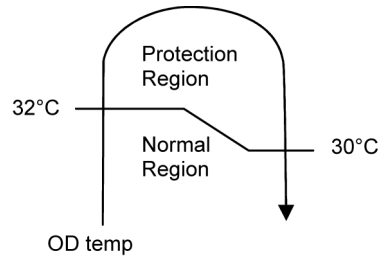

- Outdoor unit total current is above 5.0A.
- Control content
 - Outdoor fan speed is adjusted accordingly.
- Control stop condition
 - When outdoor ambient temperature is back to normal region.
- During this control, outdoor fan speed does not reduce for Quiet operation.

13.4 Electronic Parts Temperature Rise Protection 2 (Cool)

- This control prevents electronic parts temperature rise during cooling/dry operation.
- Start conditions:
 - Total current is at protection region as shown in figure below:

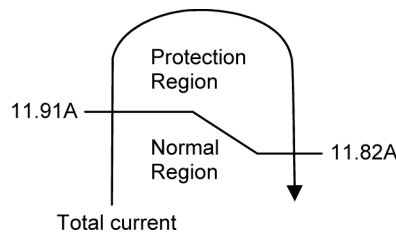

- Control content
 - Outdoor fan speed is adjusted accordingly.
- Control stop conditions
 - When total current is back to normal region.
- During this control, outdoor fan speed does not reduce for Quiet operation.

13.5 Cooling Overload Control (Cool)

- This control detect outdoor pipe temperature and perform the compressor frequency restriction during cooling operation.

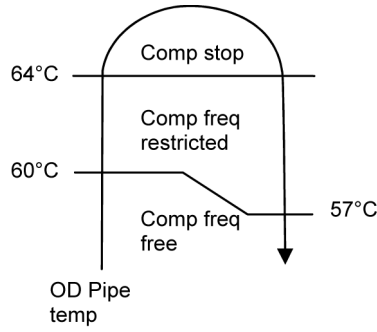

13.6 Heating Overload Control (Heat)

- This control detect indoor pipe temperature and perform the compressor frequency restriction during heating operation.

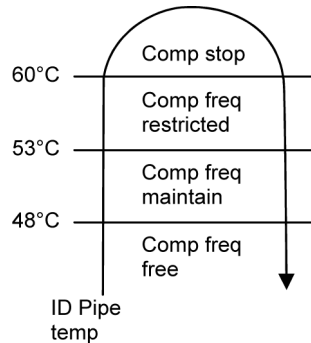

- This control detect outdoor ambient temperature and perform the fan speed adjustment during heating operation.

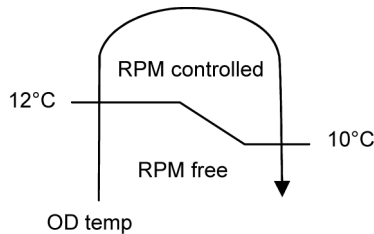

13.7 Extreme Low Temperature Compressor Low Pressure Protection Control (Heat)

- This control is to prevent low pressure drops too low during extremely low outdoor ambient temperature to improve the compressor reliability.
- During heating operation, when outdoor ambient temperature is in Zone 1, this control will be activated. Compressor frequency restriction will be based on outdoor piping temperature.

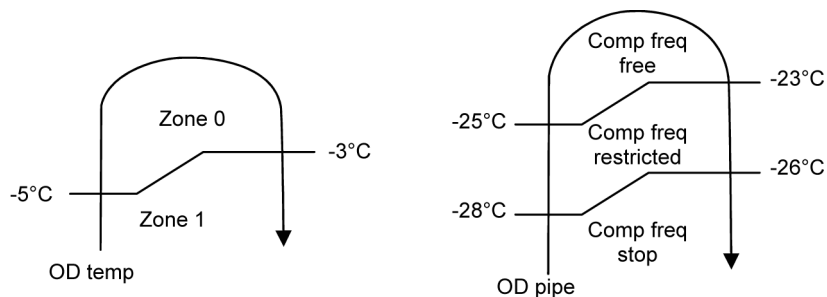

13.8 Deice Control

- When outdoor pipe temperature and outdoor air temperature is low, deice operation starts where indoor fan motor and outdoor fan motor stop, indoor unit horizontal vane close and operation LED blink with compressor ON.

13.9 Time Delay Safety Control (Restart Control)

- The compressor will not restart within three minutes after compressor is stopped.
- This control is not applicable if the power supply reset or after deice condition.

13.10 30 seconds Force Operation

- Once the compressor starts operation, it will not stop its operation for 30 seconds in order to cycle back compressor oil.
- However, it can be stopped using remote control or Auto OFF/ON button at indoor unit.

13.11 Total Current Control

- By referring to table below, during normal (default) operation, the running current refer to Hi values and during Power Save Mode, the running current refer to Lo values.
- When the outdoor unit total running current (AC) exceeds X value, compressor frequency will decrease.
- If the running current does not exceed X value for 5 seconds, compressor frequency will increase.
- However, if total outdoor unit running current exceeds Y value, compressor will be stopped immediately for 3 minutes.

Operation Mode		CU-4E27PBD		CU-5E34PBD	
		X (A)	Y (A)	X (A)	Y (A)
Cooling/Soft Dry (A)	Hi	14.0	17.5	14.0	17.5
	Lo	9.8	17.5	9.8	17.5
Cooling/Soft Dry (B)	Hi	14.0	17.5	14.0	17.5
	Lo	9.8	17.5	9.8	17.5
Heating	Hi	14.0	17.5	14.0	17.5
	Lo	9.8	17.5	9.8	17.5

13.12 IPM (power transistor) Protection Control

- Overheating Prevention Control
 - If IPM temperature rises to 80°C, outdoor fan speed will be increased.
 - When the IPM temperature rises to 95°C, compressor operation will stop immediately.
 - Compressor operation restarts when temperature decreases to 90°C.
 - If IPM temperature detected less than -30°C, IPM is judged as open circuit ("F96" is indicated).
- DC peak current control
 - When IPMDC current exceeds set value of 30.0 ± 3.0 A, the compressor will stop.
 - If the DC peak current detected within 30 seconds after operation starts, compressor will restart after 1 minute.
 - If the DC peak current detected 30 seconds or more after operation starts, compressor will restart after 2 minutes.
 - Within 30 seconds after compressor restarts, if the DC peak current is exceeded set value continuously for 7 times, all indoor and outdoor relays will be cut off ("F99" is indicated).
- Error reset can be done by power supply reset.

13.13 Compressor Protection Control (Gas leak detection control 1)

- Control start conditions
 - For 5 minutes, the compressor continuously operates and total current is low.
 - During Cooling or Soft Dry operation:
Indoor intake temperature — indoor piping temperature is below 4°C.
 - During Heating operation:
Indoor pipe temperature — indoor intake temperature is below 3°C.
 - Not during deice control.
 - Compressor ON with maximum frequency.
- Control content
 - Compressor stops (and restart after 3 minutes)
 - If the conditions above happen 4 times within 60 minutes, the unit will stop operation (“F91” is indicated).

13.14 Compressor Protection Control (Gas leak detection control 2)

- This control detect gas leakage condition to prevent compressor damage.
- Control start condition
 - All connected indoor units capability supply ON.
 - Compressor ON with maximum frequency.
 - Not during annual cooling.
 - Compressor discharge temperature high.
- Control content
 - Compressor OFF during this control (“F91” is memorized in EEPROM)
 - If the above conditions happen 2 times within 60 minutes, indoor units’ Timer LED will blinks (“F91” is indicated at all indoor units)

13.15 Valve Close Detection Control

- This control detects 3-way valve close condition to prevent damage to refrigerant cycle.
- Start conditions:
 - For all connected indoor units, if Indoor intake temperature — indoor piping temperature are between -2°C and 2°C continuously for 5 minutes after compressor ON at first cooling operation.
 - The first cooling operation is defined as cooling operation is ON for less than 8 minutes after new installation or after pump down.
- Control content
 - During this control, compressor stop, indoor units’ Timer LED will blink. (“F91” is indicated at indoor units)
- Error reset can be done by power supply reset or reset by using remote control.

13.16 Compressor Discharge High Pressure Protection Control

- This control protect by using high pressure switch during operation.
- Start conditions
 - High pressure switch is activated (from normally close to open) when outdoor operation mode is cooling or heating during compressor running.
- Control 1 content
 - Compressor stop when high pressure switch is opened and restart after high pressure switch closed. If this condition happen 4 times within 30 minutes, “F94” is indicated.
 - After 30 minutes, counter is reset if this condition does not happen for 4 times.
- Control 1 stop conditions
 - Power supply reset
 - Reset by using remote control

14. Servicing Mode

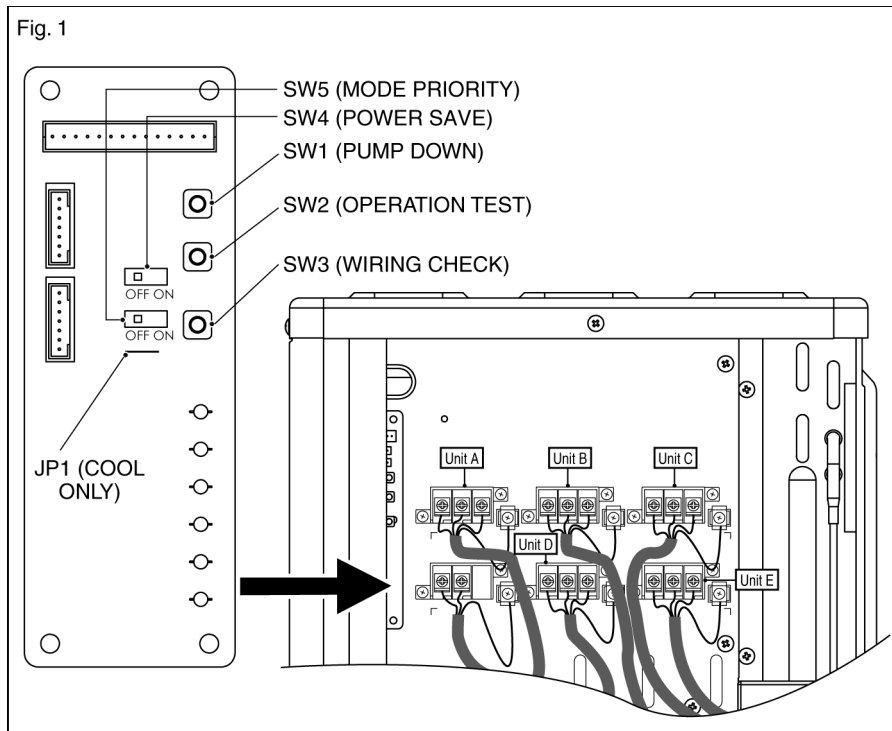

14.1.1 Pump Down Operation (SW1)

- Operate the pump down process according to the following procedure.
 - Confirm the valve on the liquid side and gas side are open.
 - Press PUMP DOWN button (SW1) on the Service PCB inside the outdoor unit for more than 5 seconds. Pump down (cooling) operation is performed for 15 minutes.
 - Set the liquid side 3 way valve to close position and wait until the pressure gauge indicates 0.01MPa (0.1kg/cm²G).
 - Immediate set the gas side valve to close position and then press the PUMP DOWN button (SW1) to stop the pump down operation.

NOTE: Pump down operation will stop automatically after 15 minutes if PUMP DOWN switch (SW1) is not pressed again. Pump down operation is not started within 3 minutes after compressor is stopped.

LED	2	3	4	5	Message
Status	○	○	○	○	Pump down operation in progress
	○	○	○		3 minutes before operation end
	○	○			2 minutes before operation end
	○				1 minute before operation end
					Pump down operation end

○: Flashing

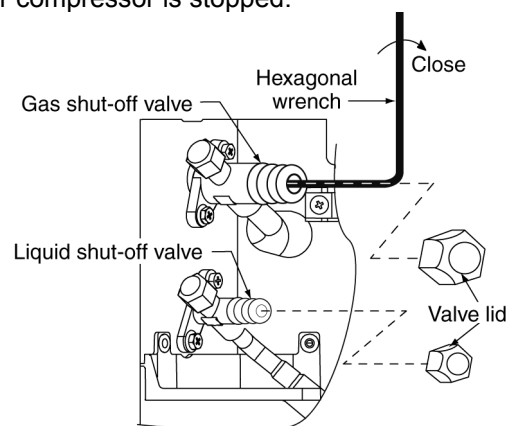

14.1.2 Test Run Operation

- Test operation can be carried out using TEST OPERATION button (SW2) on the Service PCB inside the outdoor unit.
- For Cooling test, press the TEST OPERATION button (SW2) for 5 seconds or more but less than 10 seconds, LED1 and LED 2 will illuminate when shift into cooling test operation.
- For Heating test, press the TEST OPERATION button (SW2) for more than 10 seconds, LED 1 and LED 3 will illuminate when shift into heating test operation.
- Press the TEST OPERATION button (SW2) again to cancel test operation.

14.1.3 Wiring Error Check

- The unit capable to correct the wiring error automatically by following procedures.
 - Confirm the valve on the liquid side and gas side is open.
 - Press WIRING CHECK button (SW3) on the Service PCB inside the outdoor unit for more than 10 seconds to start wiring check operation.
 - Wiring check process will complete in approximately 20 - 25 minutes. However, wiring check operation will not start within 3 minutes after compressor is stopped. When outdoor air temperature is less than 5°C or unit has abnormality, wiring check will not start. (See NOTE 2)
- The LED 2 to LED 6 in Service PCB inside the outdoor unit indicate the possibility of the correction as shown in the table below:

LED	2	3	4	5	6	Message
Room	A	B	C	D	E	
Status	All flashing					Automatic correction impossible
	LED 2, 4, 6 and LED 3, 5 alternatively flashing					Wiring check in progress
	Flashing one after another					Automatic correction completed
	Other than above					Unit has abnormality (NOTE 4)

Wiring automatic correct example

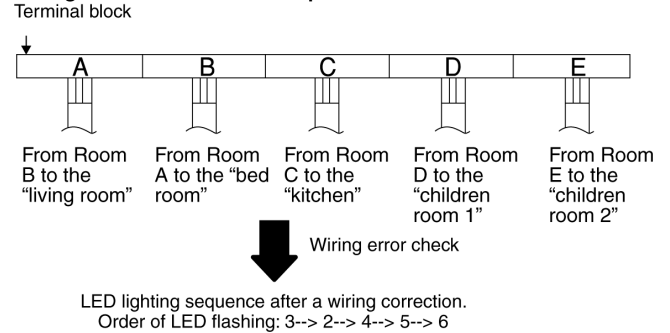

- If automatic correct is impossible, check the indoor unit wiring and piping manually.

NOTE:

- For two rooms, LED 4,5 and 6 are not illuminated, for three rooms, LED 5 and 6 are not illuminated and for four rooms, LED 6 is not illuminated after wiring operation complete.
- If the outdoor air temperature is less than 5°C or unit has abnormality, wiring operation will not start.
- After wiring check operation is complete, LED indication will illuminate until normal operation starts.
- Follow the product diagnosis procedure. (Check the diagnostic label at the cabinet side plate.)
- When LED 1 only illuminate, indicates that outdoor unit is operating normally.

14.1.4 Power Save Mode

- Power Save Mode can be enabled by pushing POWER SAVE switch (SW4) to ON before power supply ON.
- When Power Save Mode is ON, the unit can be operate at lower running current where the breaker capacity not achieve the requirement.

14.1.5 Mode Priority Function

- Mode priority function can be enabled by pushing MODE PRIORITY switch (SW5) to ON before power supply ON.
- When Mode Priority Function is ON, the mode priority is given to higher capacity indoor units.

14.1.6 Cooling Only Function

- The unit capable to limit the operation mode to Cooling Mode only (Heating mode disabled) by cutting JP1 (COOL ONLY) before power supply ON.
- This function prevent wrong operation during the unit installed in server room.
- This function could be disabled again by short the JP1 (COOL ONLY) before power supply ON.

15. Troubleshooting Guide

15.1 Self Diagnosis Function

- The display screen of wireless remote control unit and the self-diagnosis LEDs (green) on the outdoor printed circuit board in the outdoor unit can be used to identify the location of the problem. Refer to the table below to identify and solve the cause of the problem, and then re-start the air conditioner system.
- If the problem is solved and operation returns to normal. LED 1 illuminates and others LED are off.

Diagnosis display	Abnormality or protection control	LED 6	LED 5	LED 4	LED 3	LED 2	LED 1	Abnormality judgement	Protection operation	Problem	Check location
H11	Indoor/outdoor abnormal communication						○	After operation for 1 minute	Indoor fan only operation can start by entering into force cooling operation	Indoor/outdoor communication not establish	<ul style="list-style-type: none"> Indoor/outdoor wire terminal Indoor/outdoor PCB Indoor/outdoor connection wire
H12	Indoor unit capacity unmatched					○		90s after power supply	—	Total indoor capability more than maximum limit or less than minimum limit, or number of indoor unit less than two.	<ul style="list-style-type: none"> Indoor/outdoor connection wire Indoor/outdoor PCB Specification and combination table in catalogue
H15	Compressor temperature sensor abnormality					○	○	Continuous for 5s	—	Compressor temperature sensor open or short circuit	<ul style="list-style-type: none"> Compressor temperature sensor lead wire and connector
H16	Outdoor current transformer (CT) abnormality				○		○	—	—	Current transformer faulty or compressor faulty	<ul style="list-style-type: none"> Outdoor PCB faulty or compressor faulty
H27	Outdoor air temperature sensor abnormality				○	○		Continuous for 5s	—	Outdoor air temperature sensor open or short circuit	<ul style="list-style-type: none"> Outdoor air temperature sensor lead wire and connector
H28	Outdoor heat exchanger temperature sensor 1 abnormality				○	○	○	Continuous for 5s	—	Outdoor heat exchanger temperature sensor 1 open or short circuit	<ul style="list-style-type: none"> Outdoor heat exchanger temperature sensor 1 lead wire and connector
H32	Outdoor heat exchanger temperature sensor 2 abnormality			○				Continuous for 5s	—	Outdoor heat exchanger temperature sensor 2 open or short circuit	<ul style="list-style-type: none"> Outdoor heat exchanger temperature sensor 2 lead wire and connector
H33	Indoor / outdoor misconnection abnormality			○			○	—	—	Indoor and outdoor rated voltage different	<ul style="list-style-type: none"> Indoor and outdoor units check
H36	Outdoor gas pipe temperature sensor abnormality			○		○		Continuous for 5s	Heating protection operation only	Outdoor gas pipe temperature sensor open or short circuit	<ul style="list-style-type: none"> Outdoor gas pipe temperature sensor lead wire and connector
H37	Outdoor liquid pipe temperature sensor abnormality			○		○	○	Continuous for 5s	Cooling protection operation only	Outdoor liquid pipe temperature sensor open or short circuit	<ul style="list-style-type: none"> Outdoor liquid pipe temperature sensor lead wire and connector

Diagnosis display	Abnormality or protection control	LED 6	LED 5	LED 4	LED 3	LED 2	LED 1	Abnormality judgement	Protection operation	Problem	Check location
H64	Outdoor high pressure sensor abnormality			○	○			Continuous for 1 minute	—	High pressure sensor open circuit during compressor stop	<ul style="list-style-type: none"> High pressure sensor Lead wire and connector
H97	Outdoor fan motor mechanism lock			○	○		○	2 times happen within 30 minutes	—	Outdoor fan motor lock or feedback abnormal	<ul style="list-style-type: none"> Outdoor fan motor lead wire and connector Fan motor lock or block
H98	Indoor high pressure protection			○	○	○		—	—	Indoor high pressure protection (Heating)	<ul style="list-style-type: none"> Check indoor heat exchanger Air filter dirty Air circulation short circuit
H99	Indoor operating unit freeze protection			○	○	○		—	—	Indoor freeze protection (Cooling)	<ul style="list-style-type: none"> Check indoor heat exchanger Air filter dirty Air circulation short circuit
F11	4-way valve switching abnormality			○	○	○	○	4 times happen within 30 minutes	—	4-way valve switching abnormal	<ul style="list-style-type: none"> 4-way valve Lead wire and connector.
F17	Indoor standby units freezing abnormality		○					3 times happen within 40 minutes	—	Wrong wiring and connecting pipe, expansion valve leakage.	<ul style="list-style-type: none"> Check indoor/outdoor connection wire and pipe Indoor heat exchanger sensor lead wire and connector Expansion valve lead wire and connector.
F90	Power factor correction (PFC) circuit protection		○				○	4 times happen within 20 minutes	—	Power factor correction circuit abnormal	<ul style="list-style-type: none"> Outdoor PCB faulty
F91	Refrigeration cycle abnormality		○			○		4 times happen within 60 minutes	—	Refrigeration cycle abnormal	<ul style="list-style-type: none"> Insufficient refrigerant or valve close
F93	Compressor abnormal revolution		○			○	○	4 times happen within 20 minutes	—	Compressor abnormal revolution	<ul style="list-style-type: none"> Power transistor module faulty or compressor lock
F94	Compressor discharge pressure overshoot protection		○		○			4 times happen within 30 minutes	—	Compressor discharge pressure overshoot	<ul style="list-style-type: none"> Check refrigeration system
F95	Outdoor cooling high pressure protection		○		○		○	4 times happen within 20 minutes	—	Cooling high pressure protection	<ul style="list-style-type: none"> Check refrigeration system Outdoor air circuit
F96	Power transistor module overheating protection		○		○	○		4 times happen within 30 minutes	—	Power transistor module overheat	<ul style="list-style-type: none"> PCB faulty Outdoor air circuit (fan motor)

Diagnosis display	Abnormality or protection control	LED 6	LED 5	LED 4	LED 3	LED 2	LED 1	Abnormality judgement	Protection operation	Problem	Check location
F97	Compressor overheating protection		○		○	○	○	3 times happen within 30 minutes	—	Compressor overheat	• Insufficient refrigerant
F98	Total running current protection		○	○				3 times happen within 20 minutes	—	Total current protection	• Check refrigeration system • Power source or compressor lock
F99	Outdoor direct current (DC) peak detection		○	○			○	Continuous happen for 7 times	—	Power transistor module current protection	• Power transistor module faulty or compressor lock

LED 1 illuminate is indicated that outdoor unit is operating normally. If the LED 1 is switched off or flashing, check the power supply and self-diagnosis indication.

● -----	Illuminate
○ -----	Flashing
Blank -----	OFF

16. Disassembly and Assembly Instructions

 **WARNING**

High voltages are generated in the electrical parts area by the capacitor. Ensure that the capacitor has discharged sufficiently before proceeding with repair work. Failure to heed this caution may result in electric shocks.

16.1 Outdoor Unit Removal Procedure

 **Caution!** When handling electronic controller, be careful of electrostatic discharge.

16.1.1 Removing the Cabinet Top Plate

1. Remove the cabinet top plate (remove the 11 screws).

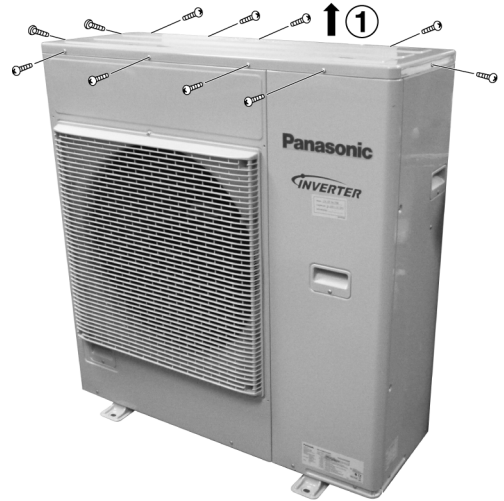

Fig. 1

16.1.2 Remove the Control Board Cover and Particular Plates

2. Remove the control board cover (remove the 5 screws).

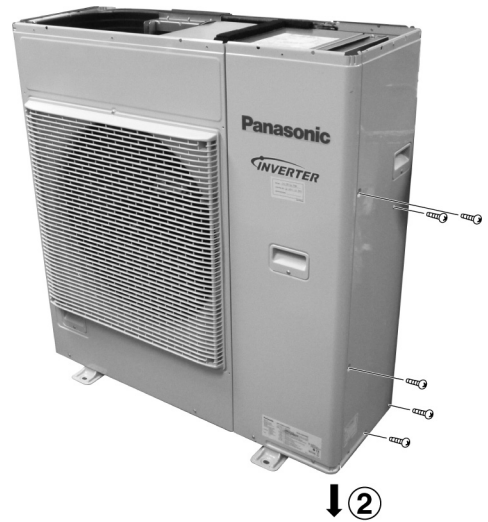

Fig. 2

3. Remove the particular plate (remove the 3 screws).



Fig. 3

4. Remove the particular plate (remove the 8 screws).



Fig. 4

16.1.3 Removing the Cabinet Front Plate

5. Remove the cabinet front plate (remove the 7 screws).



Fig. 5

16.1.4 Removing the Control P.C. Board

6. Remove the cover by release the screw.



Fig. 6

7. Disconnect the connectors (lead wires of the compressor, sensors, and others).
8. Release the Control P.C. Board tab to remove the Control P.C. Board.

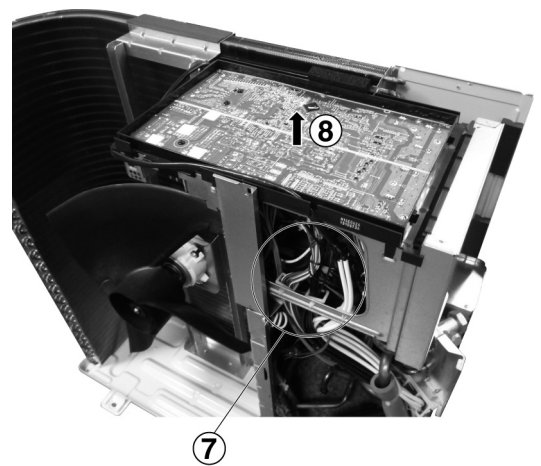

Fig. 7

16.1.5 Removing the Propeller Fan and Fan Motor

9. Remove the propeller fan by removing the nut turning clockwise as its center.
10. Disconnect the fan motor connector from the Control P.C. Board. Loosen the 4 fan motor mounting screws then remove the fan motor.

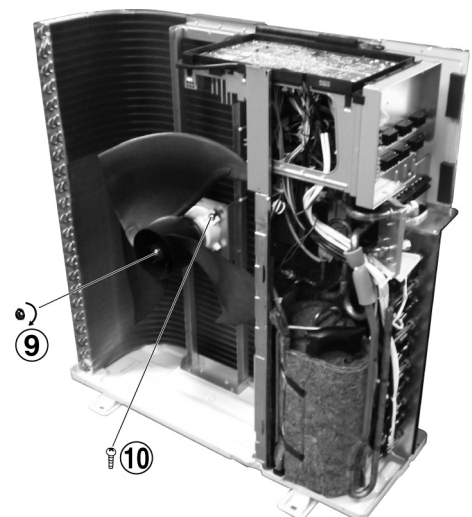

Fig. 8

17. Technical Data

17.1 Operation Characteristics

- Cooling Characteristic

[Condition] Room temperature: 27°C (DBT), 19°C (WBT)

Operation condition: High fan speed

Piping Length: 5m

230V 50Hz

A) Indoor unit capacity: Cooling (2.2: CS-E7PKDW)

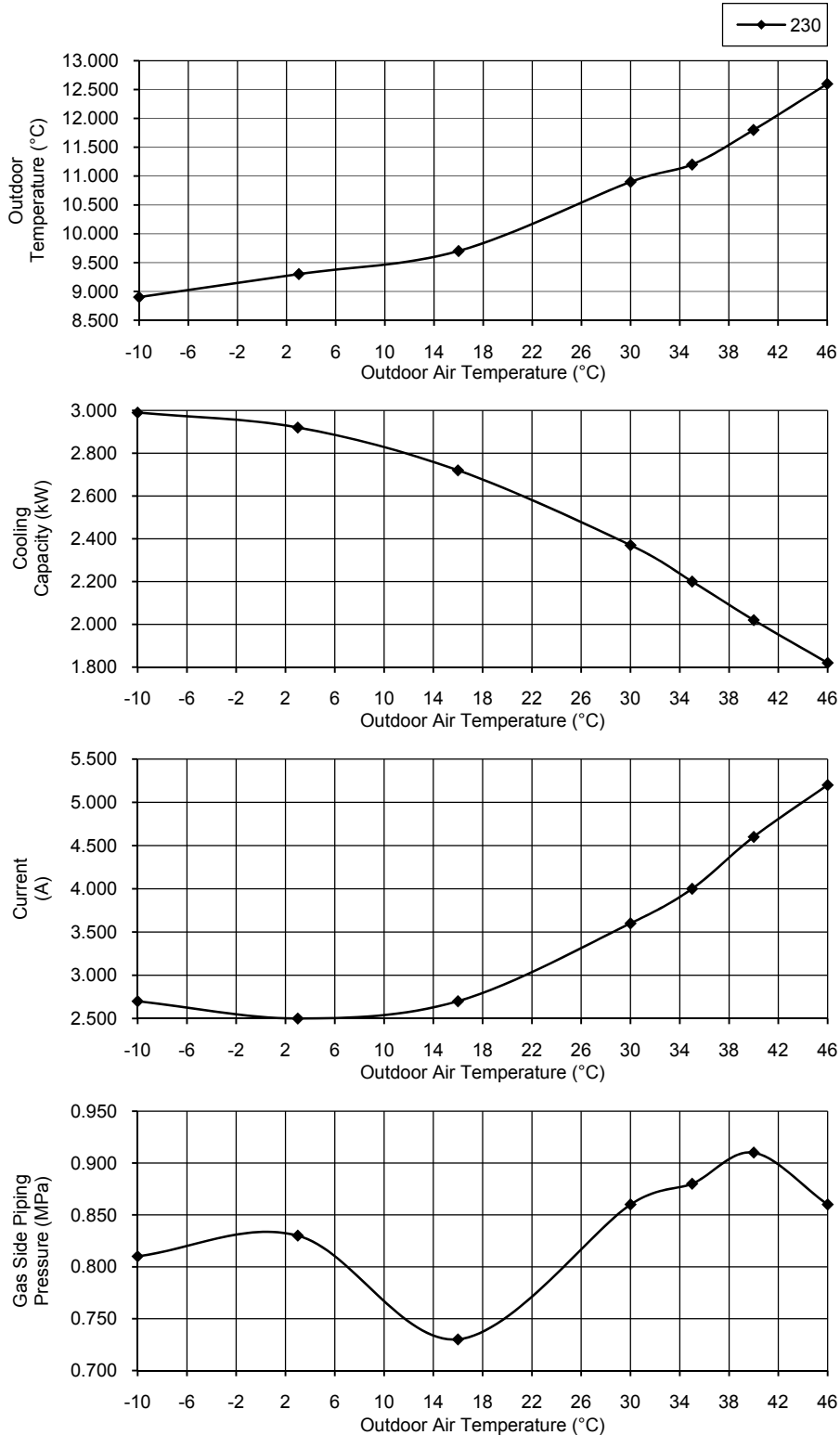

- Cooling Characteristic
- [Condition] Room temperature: 27°C (DBT), 19°C (WBT)
 Operation condition: High fan speed
 Piping Length: 5m
 230V 50Hz

B) Indoor unit capacity: Cooling (2.8: CS-E9PKDW)

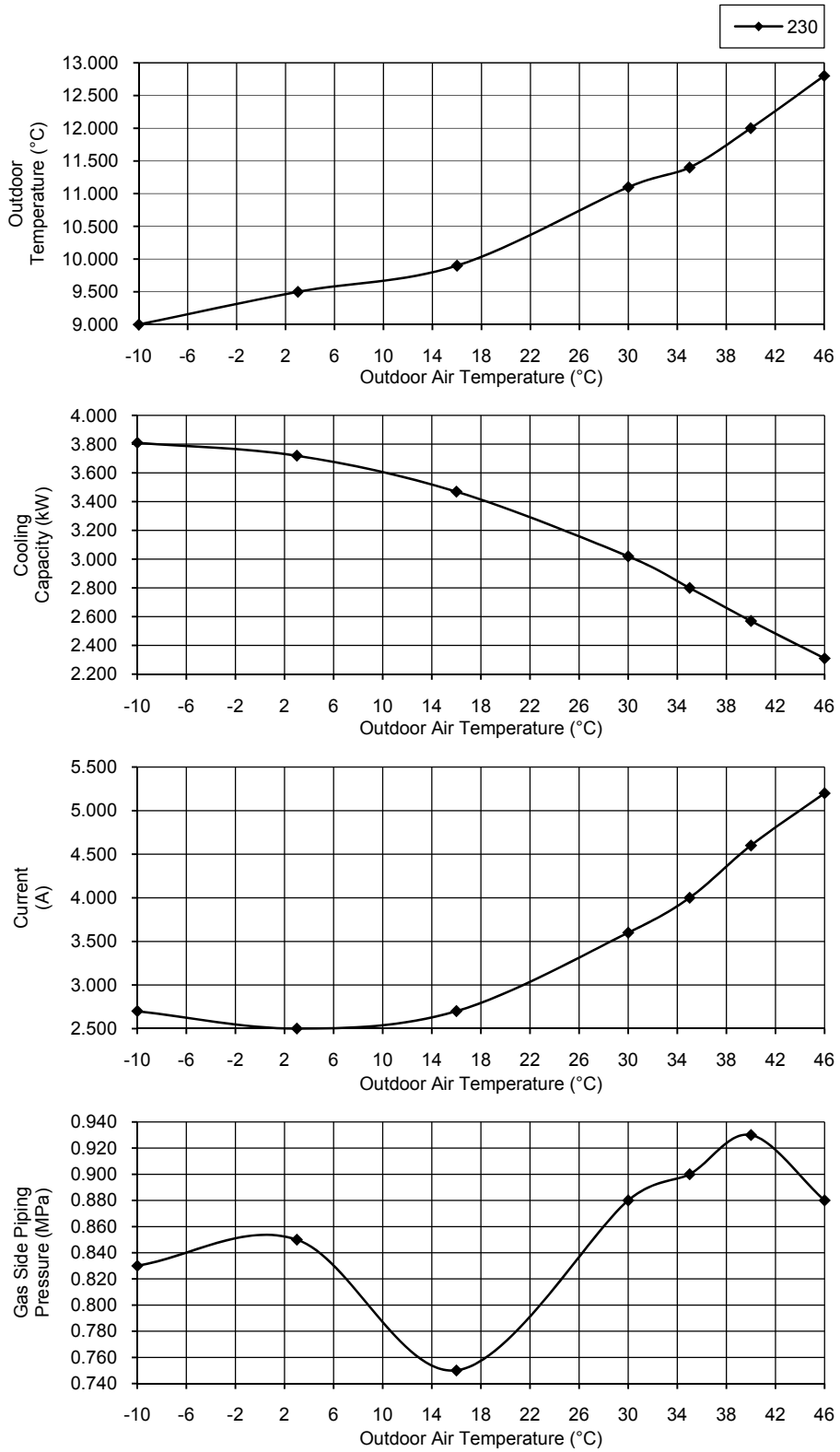

- Cooling Characteristic
 [Condition] Room temperature: 27°C (DBT), 19°C (WBT)
 Operation condition: High fan speed
 Piping Length: 5m
 230V 50Hz

C) Indoor unit capacity: Cooling (3.2: CS-E12PKDW)

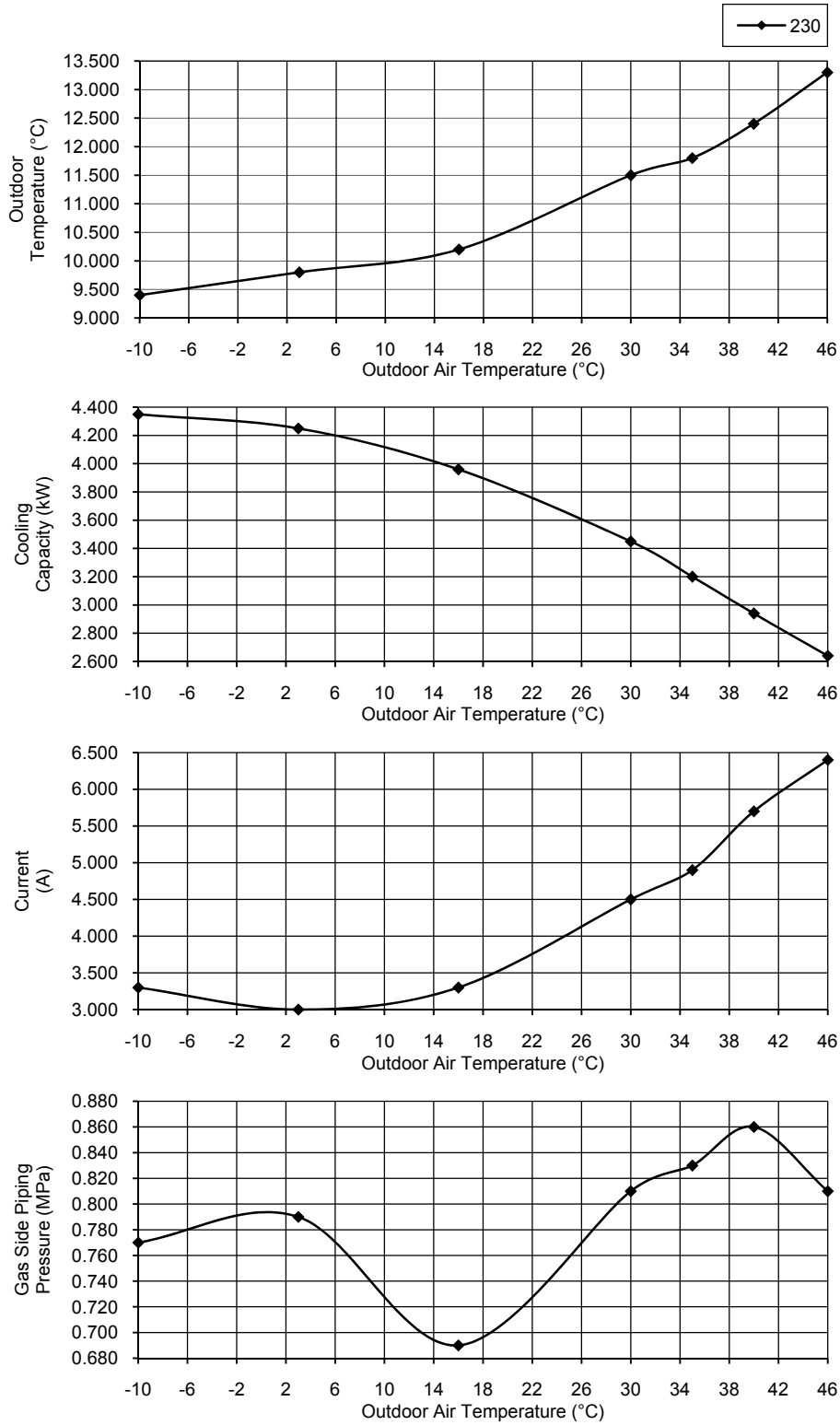

- Cooling Characteristic
 [Condition] Room temperature: 27°C (DBT), 19°C (WBT)
 Operation condition: High fan speed
 Piping Length: 5m
 230V 50Hz

D) Indoor unit capacity: Cooling (4.0: CS-E15PKDW)

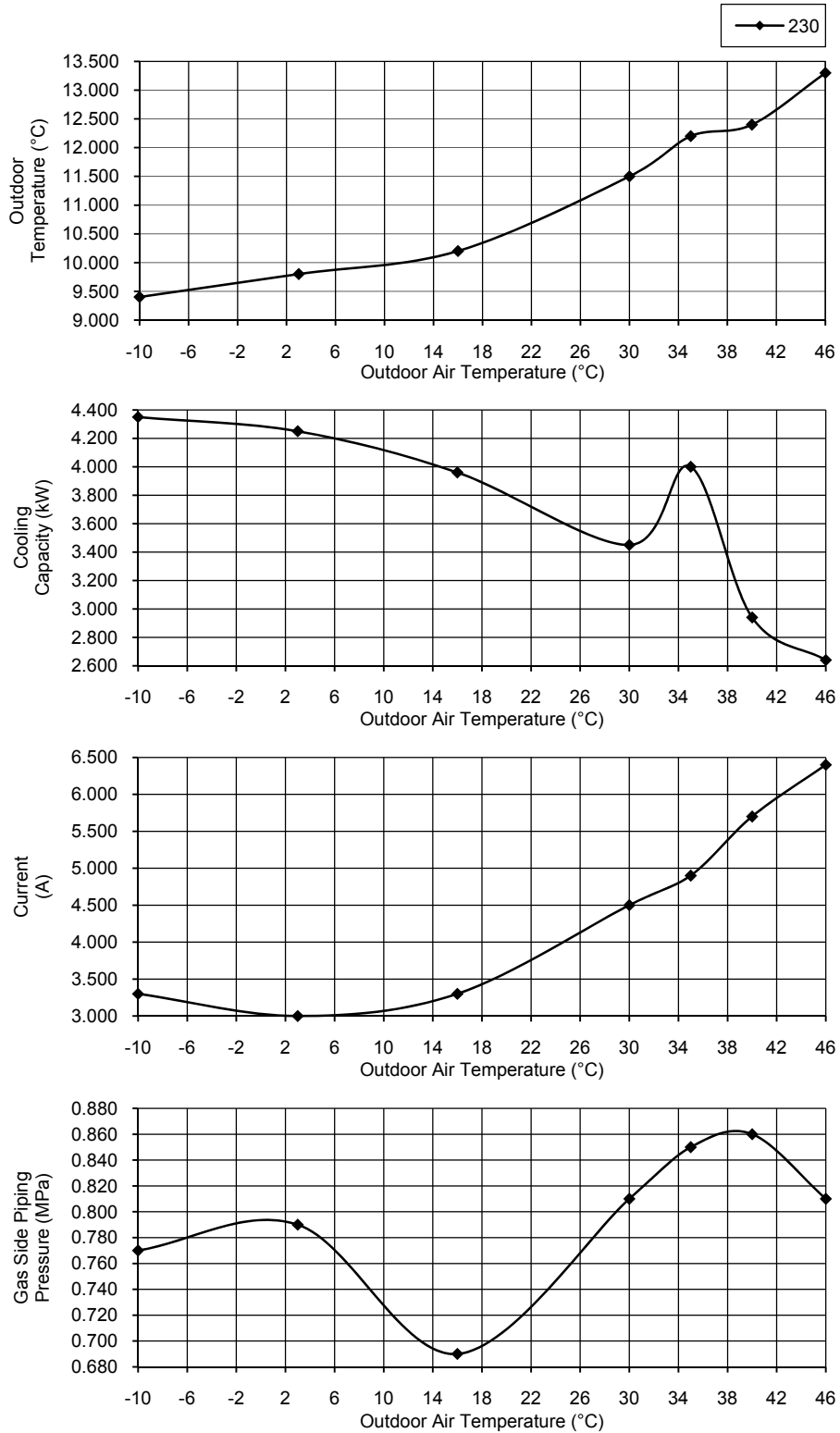

- Cooling Characteristic
- [Condition] Room temperature: 27°C (DBT), 19°C (WBT)
 Operation condition: High fan speed
 Piping Length: 5m
 230V 50Hz

E) Indoor unit capacity: Cooling (5.0: CS-E18PKDW)

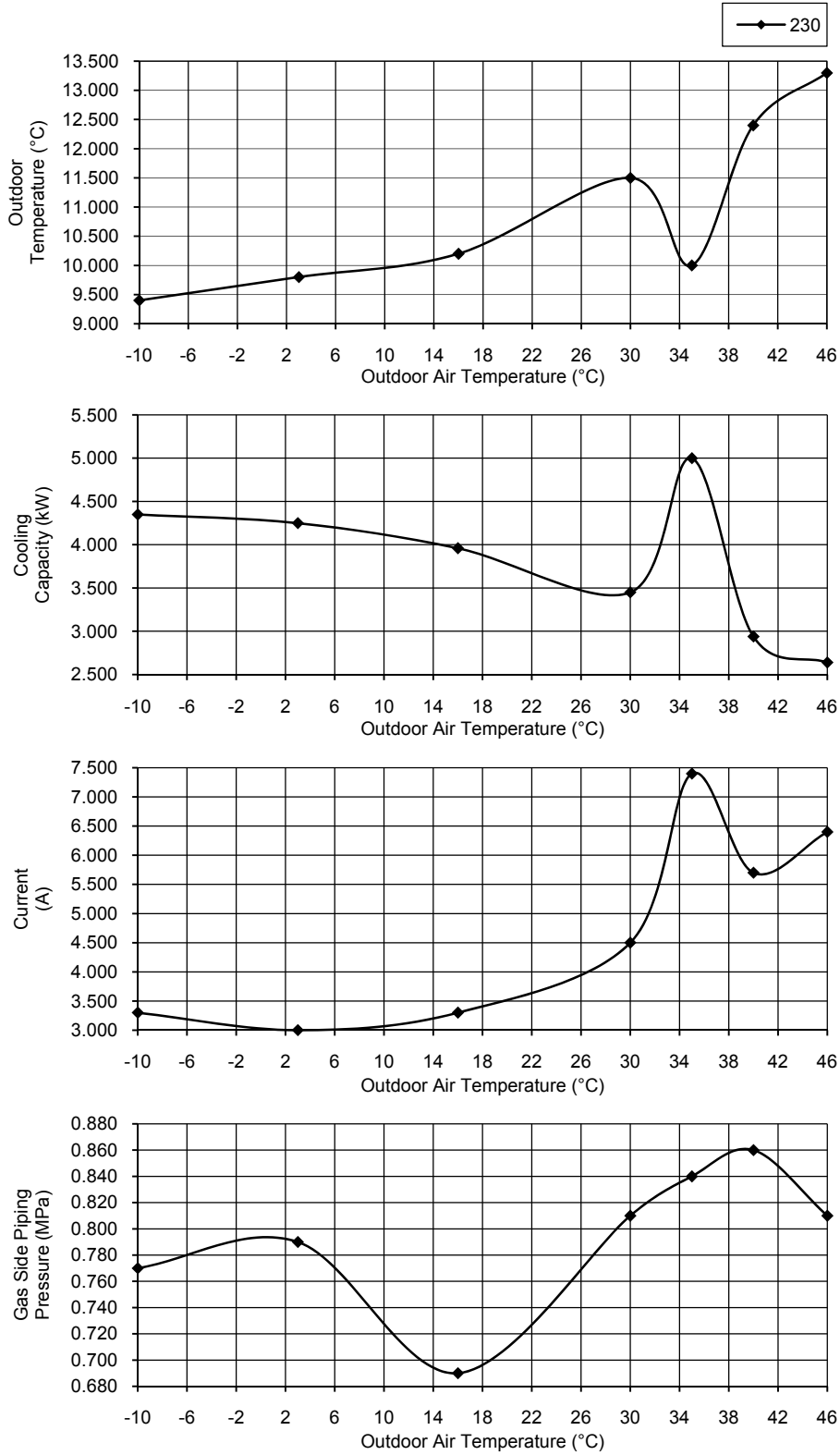

- Cooling Characteristic
- [Condition] Room temperature: 27°C (DBT), 19°C (WBT)
 Operation condition: High fan speed
 Piping Length: 5m
 230V 50Hz

F) Indoor unit capacity: Cooling (7.0: CS-E24PKDW)

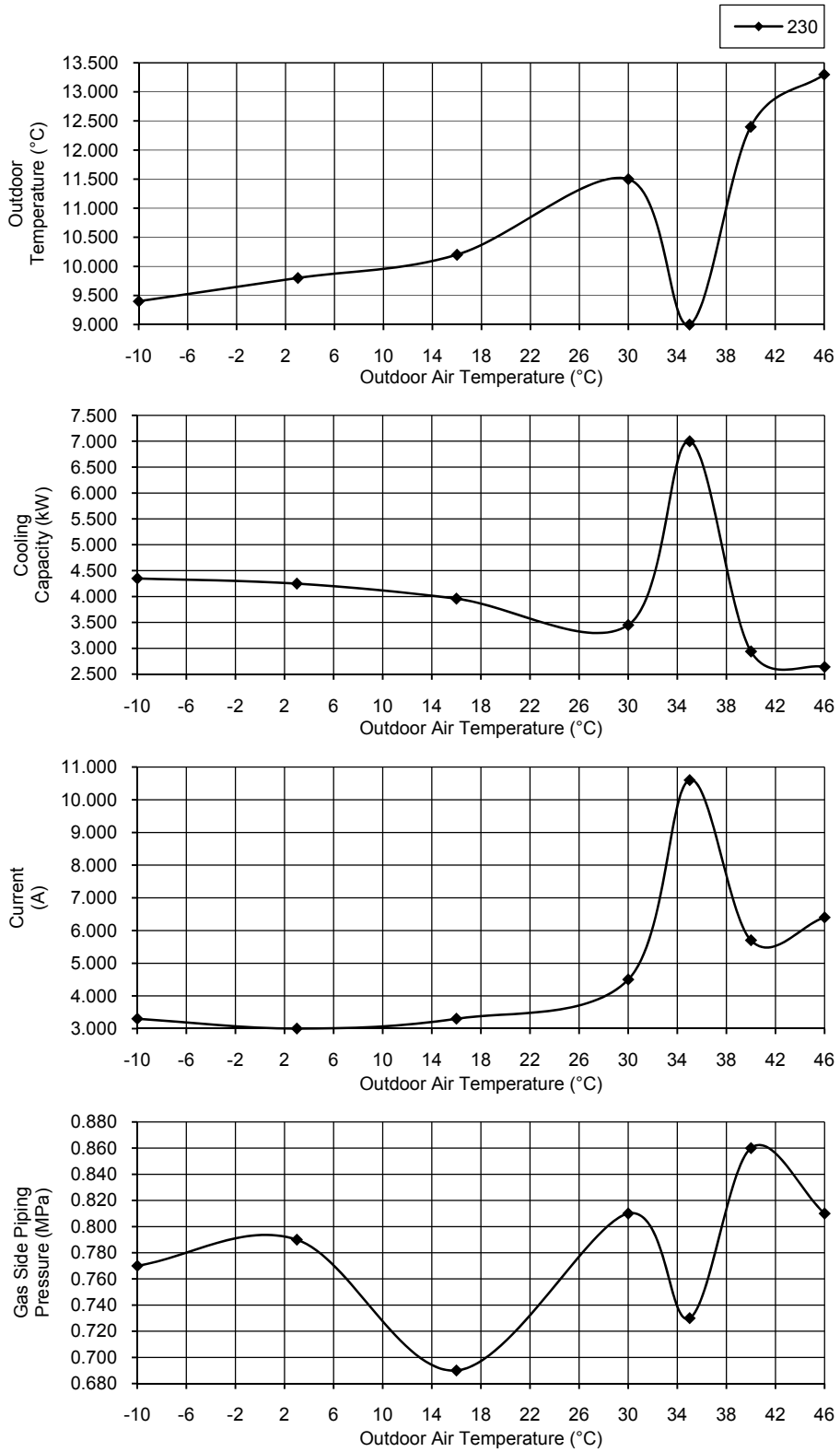

- Heating Characteristic
 [Condition] Room temperature: 20°C (DBT), 12°C (WBT)
 Operation condition: High fan speed
 Piping Length: 5m
 230V 50Hz

A) Indoor unit capacity: Heating (2.2: CS-E7PKDW)

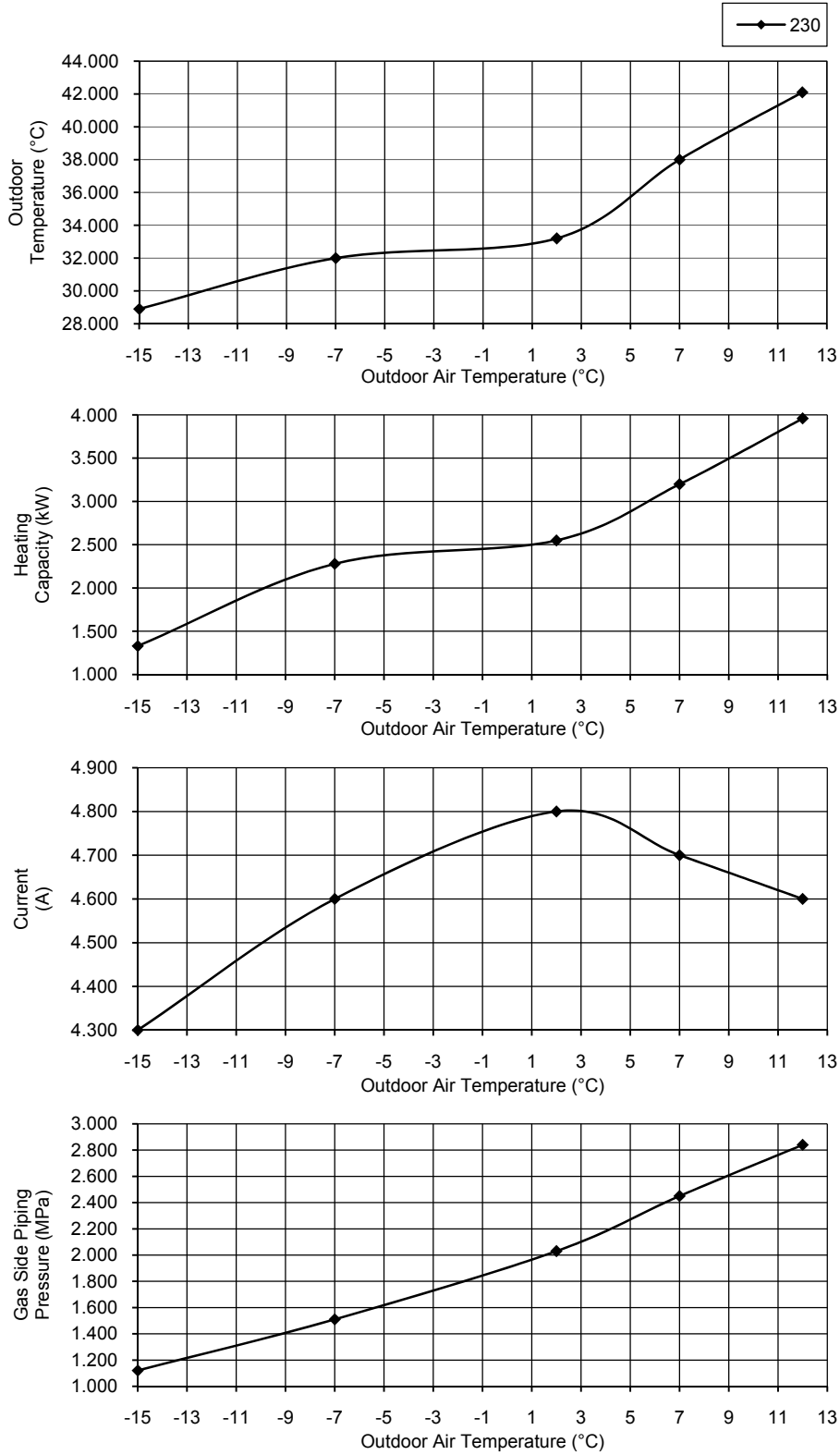

- Heating Characteristic
- [Condition] Room temperature: 20°C (DBT), 12°C (WBT)
 Operation condition: High fan speed
 Piping Length: 5m
 230V 50Hz

B) Indoor unit capacity: Heating (2.8: CS-E9PKDW)

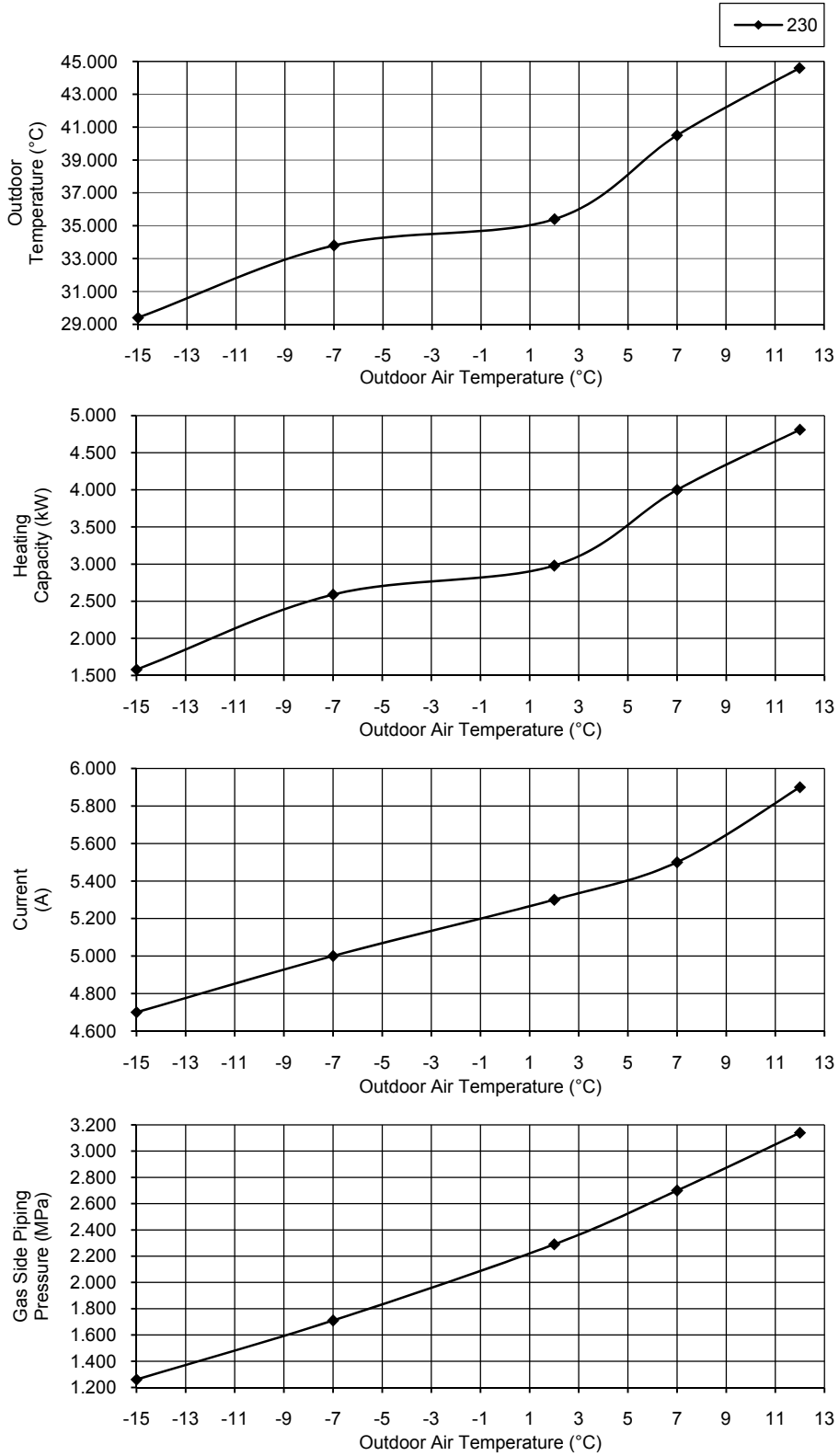

- Heating Characteristic
 [Condition] Room temperature: 20°C (DBT), 12°C (WBT)
 Operation condition: High fan speed
 Piping Length: 5m
 230V 50Hz

C) Indoor unit capacity: Heating (3.2: CS-E12PKDW)

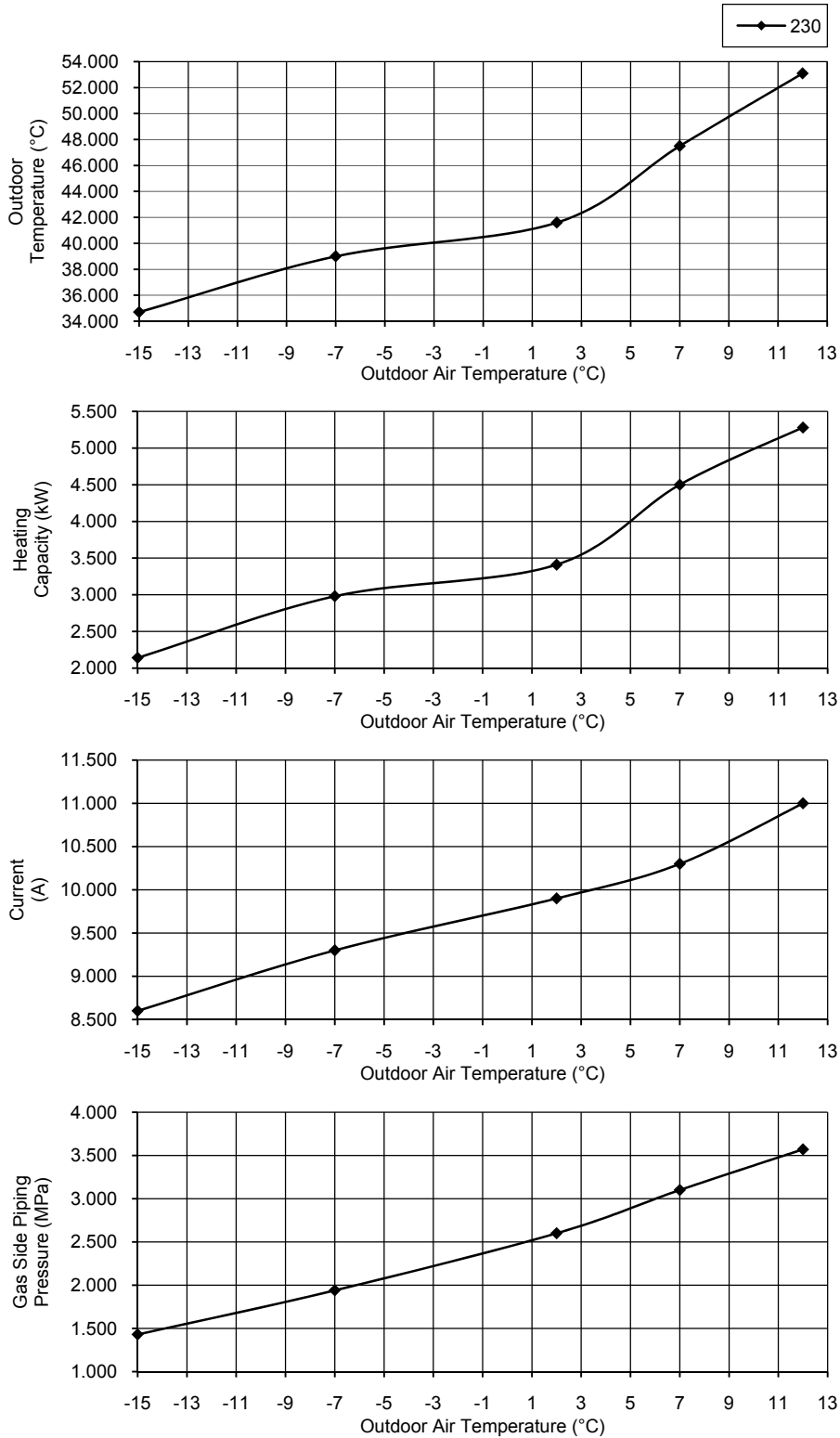

- Heating Characteristic
- [Condition] Room temperature: 20°C (DBT), 12°C (WBT)
 Operation condition: High fan speed
 Piping Length: 5m
 230V 50Hz

D) Indoor unit capacity: Heating (4.0: CS-E15PKDW)

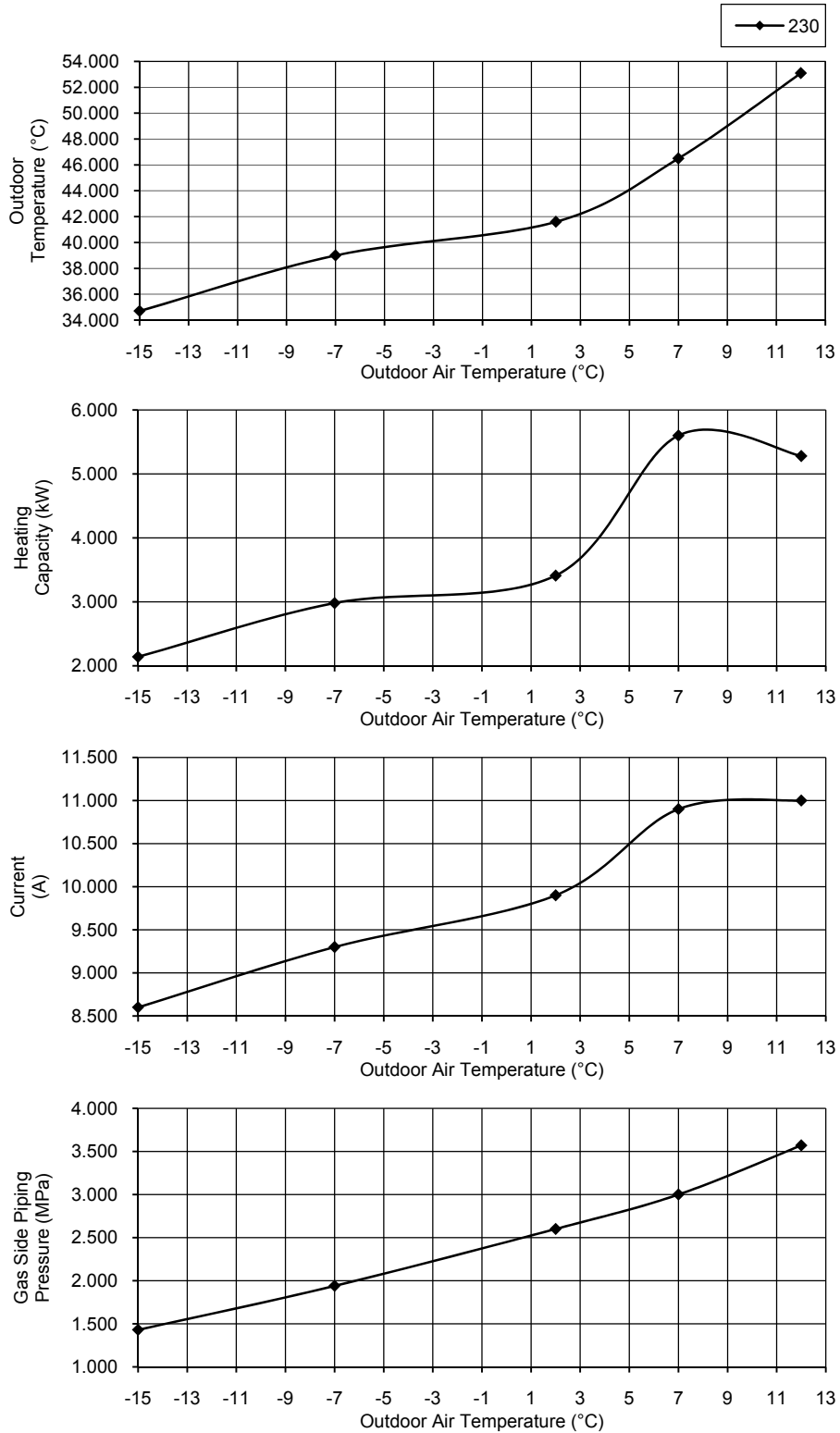

- Heating Characteristic
 [Condition] Room temperature: 20°C (DBT), 12°C (WBT)
 Operation condition: High fan speed
 Piping Length: 5m
 230V 50Hz

E) Indoor unit capacity: Heating (5.0: CS-E18PKDW)

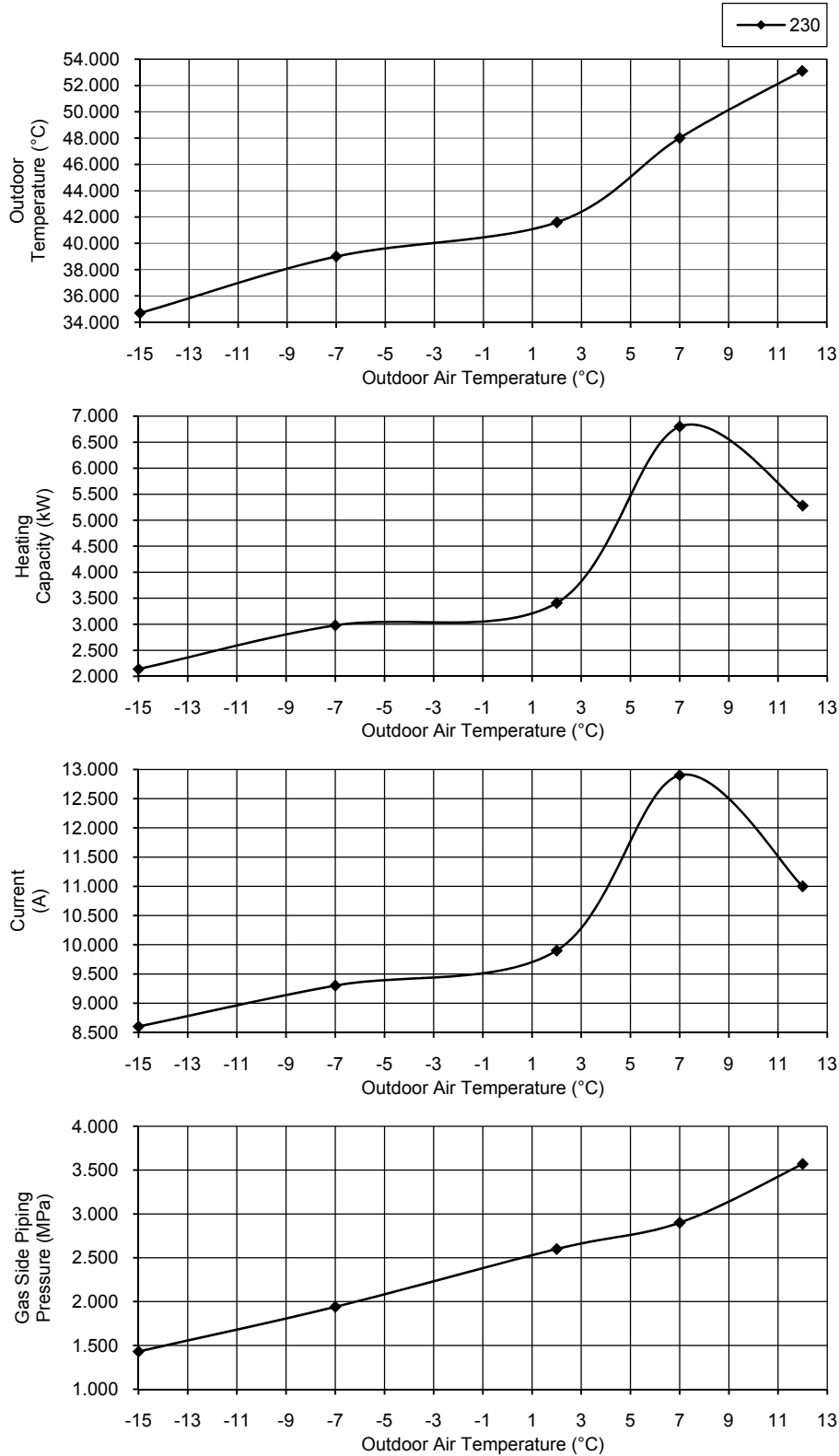

- Heating Characteristic
- [Condition] Room temperature: 20°C (DBT), 12°C (WBT)
 Operation condition: High fan speed
 Piping Length: 5m
 230V 50Hz

F) Indoor unit capacity: Heating (7.0: CS-E24PKDW)

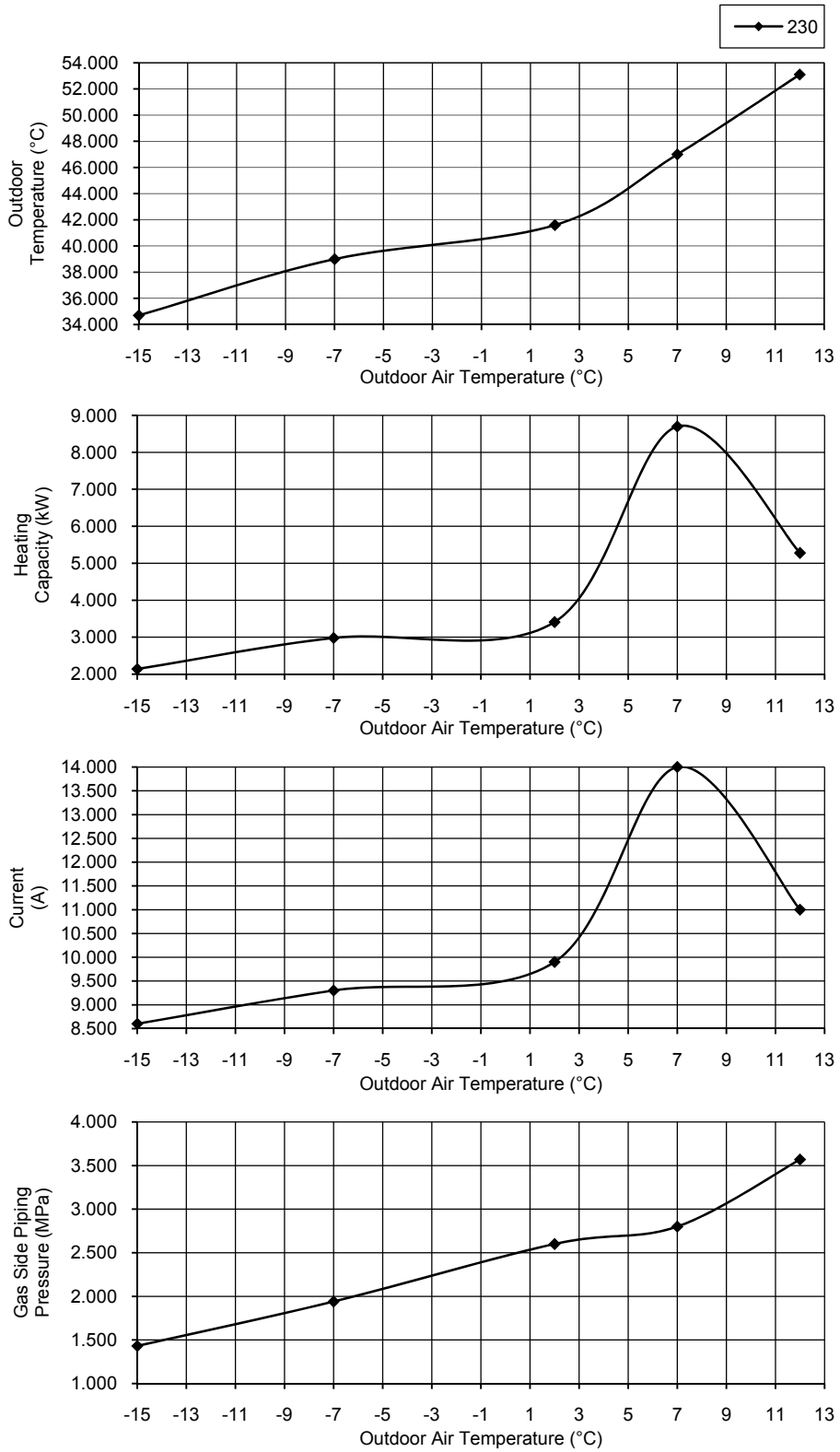

18. Exploded View and Replacement Parts List

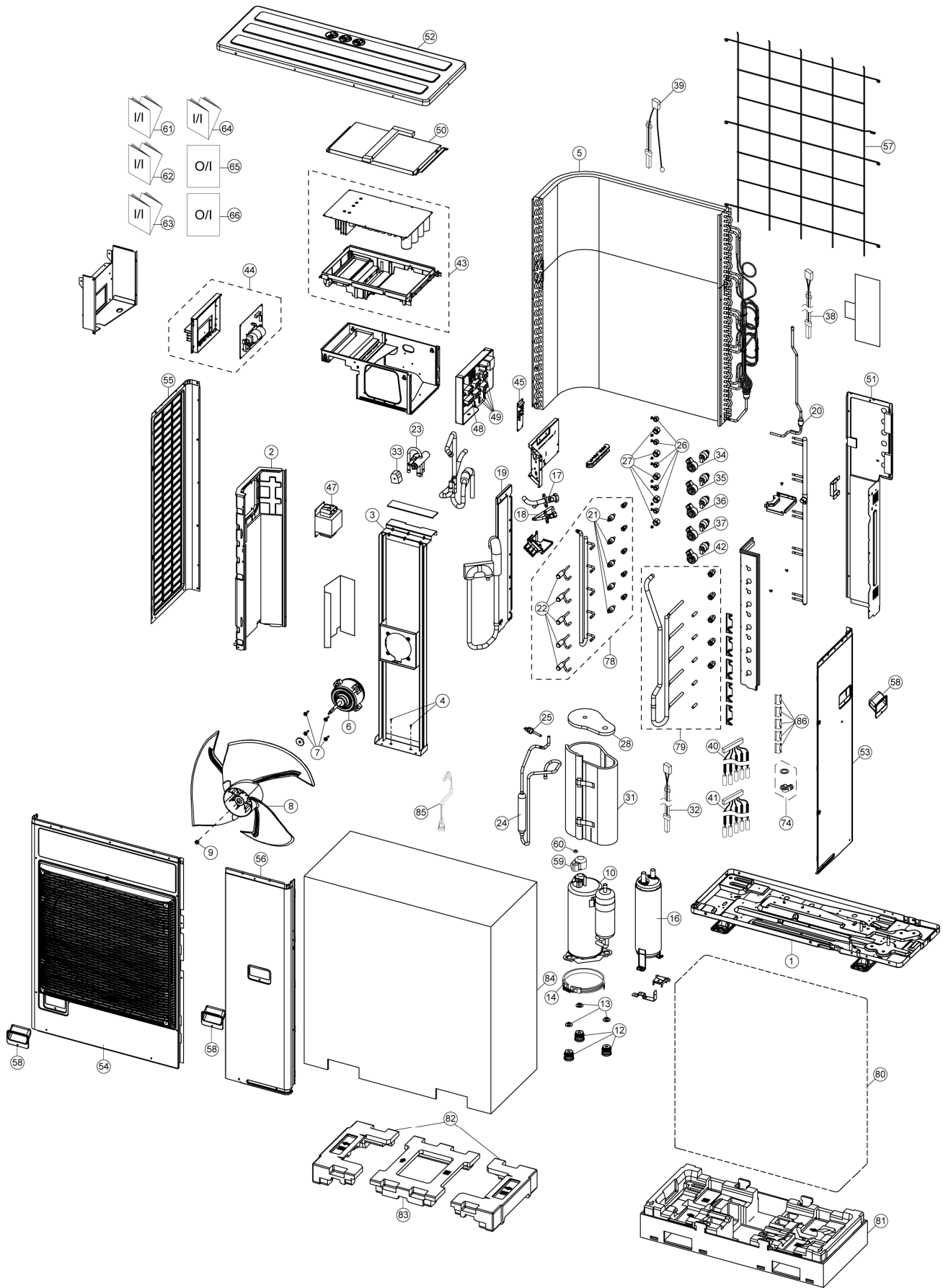

Note
 The above exploded view is for the purpose of parts disassembly and replacement.
 The non-numbered parts are not kept as standard service parts.

SAFETY	REF.NO.	DESCRIPTION & NAME	QTY.	CU-4E27PBD	CU-5E34PBD	REMARK
	1	CHASSIS ASSY	1	CWD52K1345A	←	
	2	SOUND PROOF BOARD	1	CWH151367	←	
	3	FAN MOTOR BRACKET	1	CWD54K1081	←	
	4	SCREW-BRACKET FAN MOTOR	2	CWH551217	←	
	5	CONDENSER COMPLETE	1	CWB32C3794	←	
⚠	6	FAN MOTOR	1	L6CBYYL0098	←	O
	7	SCREW-FAN MOTOR MOUNT	4	CWH551323	←	
	8	PROPELLER FAN ASSY	1	CWH03K1075	←	
	9	NUT	1	CWH561092	←	
⚠	10	COMPRESSOR	1	5KD240XAL21	←	O
	12	BUSHING - COMPRESSOR MOUNT	3	CWH50055	←	
	13	NUT-COMPRESSOR MOUNT	3	CWH561049	←	
	14	CRANKCASE HEATER	1	CWA341093	←	
	16	ACCUMULATOR	1	CWB131064	←	
	17	3-WAY VALVE (GAS)	1	CWB011769	←	
	18	3-WAY VALVE (LIQUID)	1	CWB011770	←	
	19	HOLDER COUPLING	1	CWH351262	←	
	20	STRAINER	1	CWB11061	←	
	21	STRAINER	4/5	CWB111081	←	
	22	EXPANSION VALVE	4/5	CWB051029	←	
	23	4-WAYS VALVE	1	CWB001026J	←	
	24	DISCHARGE MUFFLER	1	CWB121014	←	
	25	HEATING PRESSURE SWITCH	1	CWA101013	←	
	26	FLARE NUT (1/4)	4/5	CWT251030	←	
	27	FLARE NUT (3/8)	4/5	CWT251031	←	
	28	SOUND PROOF MATERIAL	1	CWG302804	←	
	31	SOUND PROOF MATERIAL	1	CWG302801	←	
	32	SENSOR COMPLETE – DIS (CN-DIS)	1	CWA50C3091	←	O
⚠	33	V-COIL COMPLETE (4 WAY VALVE)	1	CWA43C2586	←	O
⚠	34	V-COIL COMPLETE (EXPAND VALVE-WHITE CN-EV1)	1	CWA43C2587	←	O
⚠	35	V-COIL COMPLETE (EXPAND VALVE-YELLOW CN-EV2)	1	CWA43C2588	←	O
⚠	36	V-COIL COMPLETE (EXPAND VALVE-BLUE CN-EV3)	1	CWA43C2589	←	O
⚠	37	V-COIL COMPLETE (EXPAND VALVE-RED CN-EV4)	1	CWA43C2590	←	O
	38	SENSOR-COMPLETE – DEF (CN-TH2)	1	CWA50C3087	←	O
	39	SENSOR COMPLETE (OUTLET TEMP SENSOR) (CN-TH1)	1	CWA50C3088	←	O
	40	SENSOR-COMPLETE (CN-TH4)	1	CWA50C3131	CWA50C3089	O
	41	SENSOR-COMPLETE (CN-TH3)	1	CWA50C3132	CWA50C3090	O
⚠	42	V-COIL COMPLETE (EXPAND VALVE-BLACK CN-EV5)	1	-	CWA43C2591	O
⚠	43	ELECTRONIC CONTROLLER (MAIN)	1	CWA73C7802R	CWA73C7801R	O
⚠	44	ELECT. CONTROLLER -NOISE FILTER	1	CWA73C7265	←	O
⚠	45	ELECTRONIC CONTROLLER (DISPLAY)	1	CWA747223	←	O
⚠	47	REACTOR	1	G0C602J00009	←	
⚠	48	TERMINAL BOARD ASSY (L, N)	1	CWA28K1195	←	
⚠	49	TERMINAL BOARD ASSY (1, 2, 3)	4/5	CWA28K1196	←	
	50	CONTROL BOARD COVER	1	CWH131613	←	
	51	CABINET REAR PLATE	1	CWE02C1078	←	
	52	CABINET TOP PLATE	1	CWE03C1150	←	
	53	CONTROL BOARD COVER	1	CWE04C1462	←	
	54	CABINET FRONT PLATE	1	CWE06C1475	←	
	55	CABINET SIDE PLATE	1	CWE041734A	←	
	56	CABINET SIDE PLATE	1	CWE06C1476	←	
	57	WIRE NET	1	CWD041203A	←	
	58	HANDLE	3	CWE161021	←	
	59	TERMINAL COVER	1	CWH171039A	←	
	60	NUT-TERMINAL COVER	1	CWH7080300J	←	

SAFETY	REF.NO.	DESCRIPTION & NAME	QTY.	CU-4E27PBD	CU-5E34PBD	REMARK
	61	INSTALLATION INSTRUCTION	1	CWF615847	←	
	62	INSTALLATION INSTRUCTION	1	CWF615889	←	
	63	INSTALLATION INSTRUCTION	1	CWF615890	←	
	64	INSTALLATION INSTRUCTION	1	CWF615891	←	
	65	OPERATING INSTRUCTION	1	CWF569016	←	
	66	OPERATING INSTRUCTION	1	CWF569017	←	
	74	ACCESSORY CO. (DRAIN ELBOW)	1	CWG87C900	←	
	78	TUBE ASS'Y (LIQUID SIDE)	1	CWT029448	CWT029390	
	79	MANIFOLD TUBE ASS'Y (GAS SIDE)	1	CWT029449	CWT029391	
	80	BAG	1	CWG861520	←	
	81	BASE BOARD-COMPLETE	1	CWG62C1172	←	
	82	SHOCK ABSORBER	2	CWG713581	←	
	83	SHOCK ABSORBER	1	CWG713582	←	
	84	C.C. CASE	1	CWG569517	←	
	85	LEAD WIRE - COMPRESSOR	1	CWA68C1395	←	
	86	HOLDER SENSOR	5	CWH321111	←	

(Note)

- All parts are supplied from PAPAMY, Malaysia (Vendor Code: 00029488).
- "O" marked parts are recommended to be kept in stock.